

# Shower & Spa Systems

Waterproofing System Solutions for tiled wet rooms

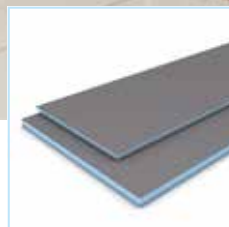



01

03

04

# wedi – Only real with a blue core

01 wedi Building Panels' reinforced cement resin surface offers a superior bond surface to virtually any tile and stone or tile adhesive. No delamination, no surprises.

02 The blue XPS core is 100% waterproof and remains fully functional even after possible partial damage. Our XPS brand foam is specially engineered for 100% consistency of its closed cell structure.

03 All building panel systems have great heat insulation properties, save energy costs and provide long-term protection against mould due to its inorganic nature and ability to safely waterproof.

04 wedi Building Panels can be safely adhered and sealed in assemblies using wedi Joint Sealant: strong reinforcement, bond and waterproofing with virtually no build up as with conventional taping. As no other seal is necessary, craftsmen benefit from increased protection accompanied by a shorter surface preparation time before tiling starts.

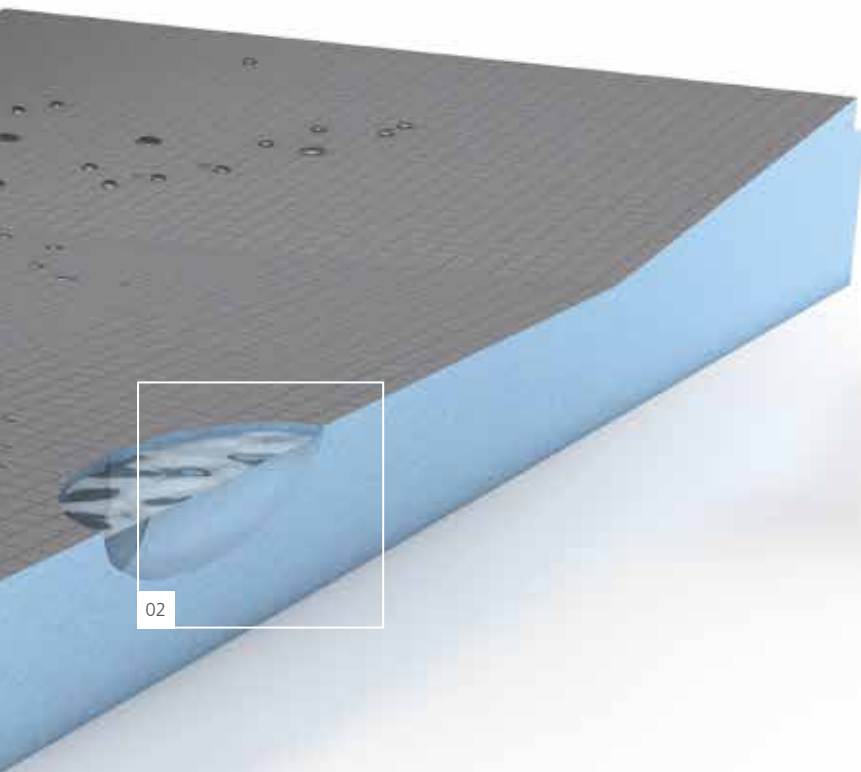

100% waterproof – with manufacturer's guarantee



Easy and safe modular installation



Fastest installation of waterproof, custom tiled showers in the industry



Multiple customisable products sizes



Natural protection against mould



Ready to tile upon installation – Any size or type tile & stone



01 wedi Building Panel XXL, for shower walls and wet areas ▪ [Page 15](#)

02 wedi Building Panel XL, large design for use as a partition wall, for example ▪ [Page 14](#)

03 wedi Building Panel, the perfect tiling sub-structure for walls and floors ▪ [Page 12](#)

04 wedi Building Panel, easily and cleanly shaped on site to fit individual designs ▪ [Page 13](#)



05 wedi Wellness Loungers, ready to tile and optional with integrated heating  
 ▪ [Page 54](#)

06 wedi Fundo shower floor elements, a wide variety of floor-level or hob design showers ▪ [Page 17](#)

07 wedi Sanbath Tubs – prefabricated tubs including integrated plumbing: plug in and tile ready in minutes  
 ▪ [Page 58](#)

08 wedi joint sealant, permanently flexible, waterproof and a strong adhesive for perfect joint treatment ▪ [Page 47](#)

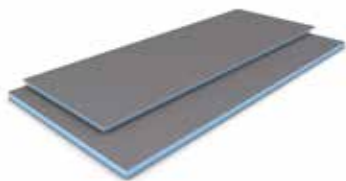

**01** wedi Building Panels  
Perfect substrate for practically any wall or floor application.



**02** wedi Fundo Primo  
The original wedi Fundo: Robust, pre sloped, waterproof, shower floor bases with 100 x 100 mm drain cover. Customisable on site.



**03** wedi Fundo Riolito neo/Riolito neo Modular  
Fully factory integrated linear drainage. Models include one-way, two-way and four-way slope designs. Customisable on site.

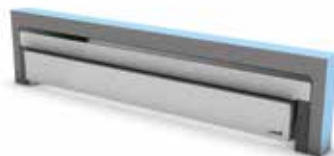

**04** wedi Fundo Ligno  
Our newest Fundo model: Floor level 19 mm profile designed especially for suspended wood subfloors. Like all wedi shower bases it is pre sloped, and waterproof. Comes with 100 x 100 mm drain cover. Customisable on site.

**05** wedi Fundo Discreto  
Wall drain module for integration in seats or false walls. Installs over select Riolito neo linear drain models. Cover is tileable on one side and polished stainless steel on reverse side.

**06** wedi Fundo Primo Drains & Covers  
The perfectly easy to use compression fit black PVC drain is always included with a standard Drain Cover Set.



**07** wedi Shower Benches  
 Prefabricated, slightly sloped bench options  
 or simply built on site to fit using wedi 51 mm  
 Building Panel



**08** wedi Wall Mounted Triangle Seat  
 Suspended seat solution, equipped with  
 mounting bracket system for installation into  
 existing framing



**09** wedi Niches  
 The perfect fit for all shower necessities





**10** wedi Hobs  
For shower entry design where safe and sound transitions are required

**11** wedi Sloped Shower Ramps  
Where wheelchair accessible or Code compliant entries are required

**12** wedi Shower Base Extension  
Extend any wedi shower floor base type using pre-sloped extension modules featuring pre-made connections to any base



# Building Panel Applications

## The Ultimate Tile Backerboard

wedi Building Panels are so much more than a simple tile backer board and offer endless installation opportunities. Available in a wide variety of thicknesses and sizes, they are compatible with virtually any substructure. wedi Building Panels are lightweight, internally waterproof and dimensionally stable, making them fast, clean and simple to work with. The blue waterproof core is CFC- and HBCD free, made from waterproof extruded polystyrene foam, reinforced with fiberglass mesh on both sides and coated with synthetic polymer resin mortar which fully embeds the mesh layer resulting in the panel's strength and the ability to develop highest adhesion strength to virtually any type of Thinbed Mortar. The embedded mesh eliminates the risk of delamination of installation layers.

The wedi Building Panel combines the benefits of the latest manufacturing technology and material quality with sound and traditional benefits our trades enjoy. wedi Building Panels are waterproof, lightweight, easy and clean to cut and still incredibly strong and bond friendly for use with any type of thinset mortar application. The wedi Building Panel can be tiled with all types of ceramic, glass or stone tile whether they are mosaic or large format tiles. Especially large and thin tile benefits of the durability of the wedi Building Panel and the even surface it provides.

## The Ultimate and Complete Wet Room tile backer board and integral part of the wedi Shower System

wedi Building Panels have a blue core made from CFC- and HBCD free extruded polystyrene rigid foam. This makes wedi building panels an ideal base for any type of thinset adhered tile or stone. wedi Building Panels can be applied to practically any loadbearing substrate, are waterproof throughout, insulating, versatile in its use in field customised applications, light and extremely robust and strong. While often used within the range of wedi shower systems it is also a formidable tile backer board for use on walls, floors, countertops and many more applications.

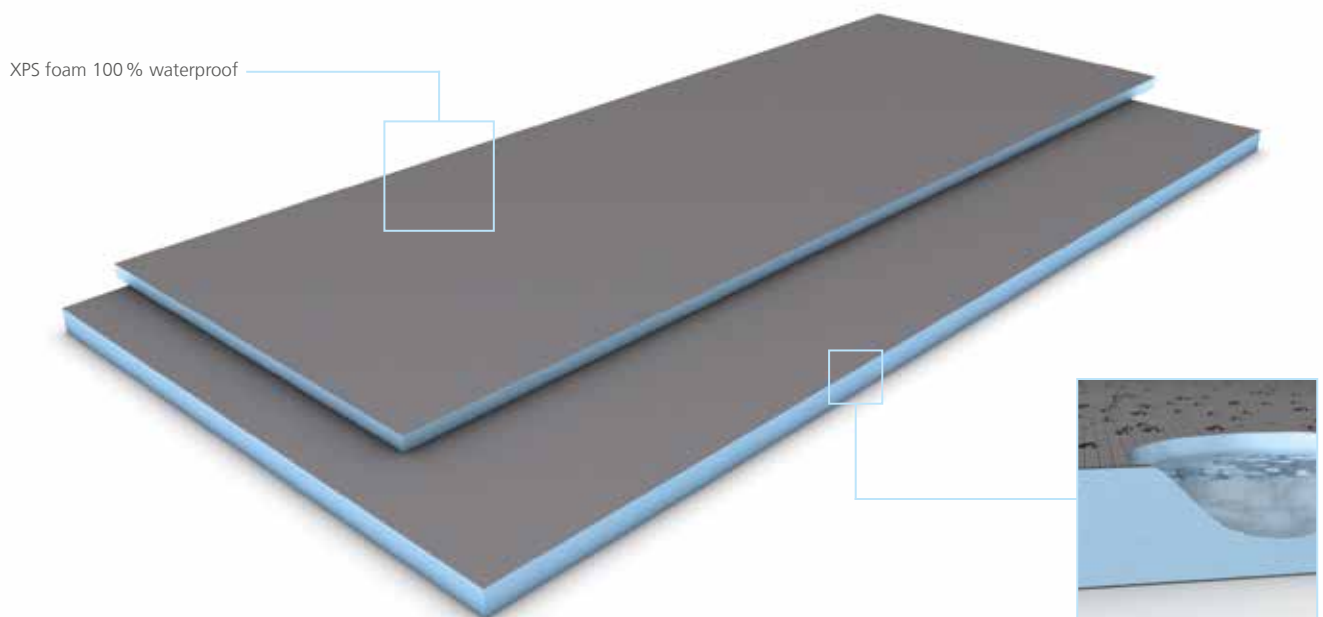

- 100 % waterproof blue core, made from CFC-free, HBCD-free extruded polystyrene closed cell foam
- Available in multiple thicknesses and sizes
- Compatible with virtually any stable substructure
- Versatile, limitless installation capabilities
- Strong, due to cement resin with embedded mesh reinforcement – no chance for delamination
- Superior bond to any tile using any thinset mortars on cement or epoxy basis
- Extremely light weight, easy and clean to cut
- Includes thermal insulating properties
- Protects against mould and mildew naturally
- Perfect, even surface for mosaics, as well as large size or thin body tile

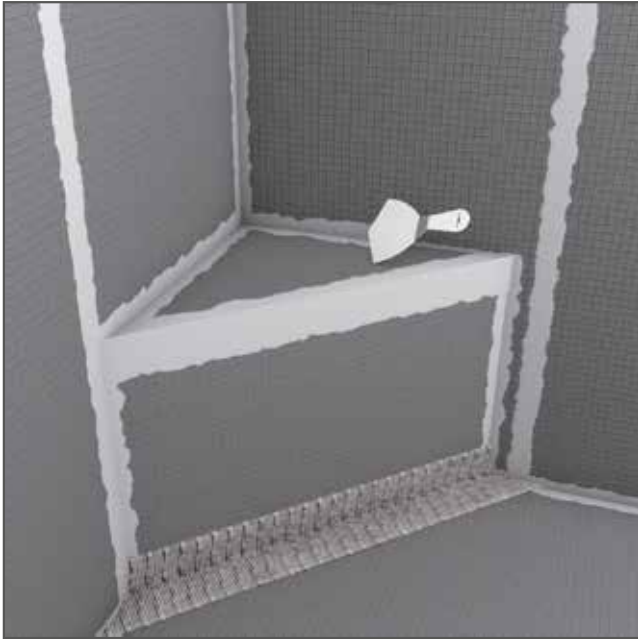

## Building Custom Seats and Benches Using 40 and 50 mm thick wedi Building Panels

wedi offers prefabricated suspended or wall mounted seats and floor standing seats. Both may also be constructed on site using wedi Building Panels. This is an ideal option that will perfectly accommodate your individual tile and design layout.

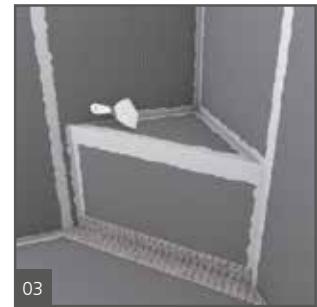
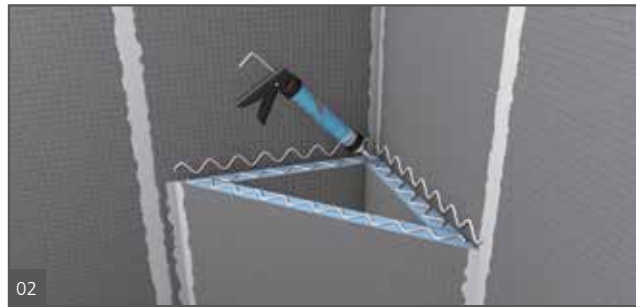
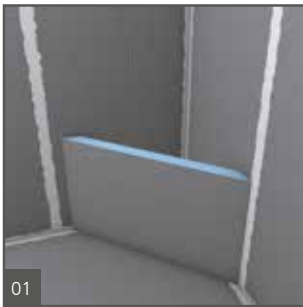

Measure and cut the bench pieces off a wedi 50 mm thick Building Panel and dry fit. When installing a corner seat, the panel edges are mitered for a tight fit. To achieve a slope, the part's upper ends are cut down with a slight angle towards the front of the bench. Optionally, create a pitch using wedi joint sealant as a 'wet shim'. The wedi parts

are adhered to the wall using thinset mortar or wedi Joint Sealant. Adjoining parts are glued together using wedi Joint Sealant continuously applied along all foam edges of a panel part. Excess is spread flat over the seams using a putty knife. Where the part's backs meet the wedi wall, modified thinset mortar is used in a full contact

surface bed. Once the bench is built, a final bead of wedi Joint Sealant is applied to safely seal all seams to the wedi wall. The vertical front part of the bench will show a small gap to the pitched floor. Please fill with thinset mortar and alkali resistant fiberglass mesh tape by wedi, applied over this seam. Alternatively, benches

and seats are offered as prefabricated units made by wedi. For longer or larger benches built from our 50 mm building panel, always install one spacer every 400 mm in either direction. Cover exposed blue foam panel edges with wedi joint sealant or a strip of wedi Building Panel so even small tiles can be adhered safely.

## Tools and Methods to cut wedi Building Panels into flexible shapes – curved bench styles

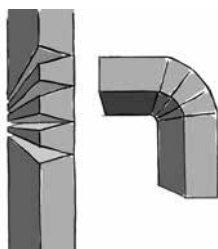

Cut the wedi Building Panel using a utility knife and straight edge. This way wave shape constructions can be produced. For a small radius – cut out wedges from the building panel or...

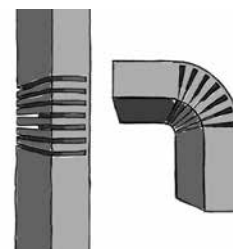

... cut the wedi Building Panel using a hand-held circular saw and bend it into a curve.



## Shower Walls and Wet Areas

The wedi Building Panels can be applied to shower walls and wet areas perpendicular or parallel to the framing, saving time and reducing joint frequency. The panels are fastened quickly and easily in place using wedi fasteners. Once the panels are secured and seams and fasteners are sealed with wedi Joint Sealant, tiling can begin immediately. All in a fraction of the time previously required by traditional methods. The wedi Building Panel combines tile backer board and waterproofing in one product and installation step. This saves time and cost. Its solid waterproof core eliminates concerns typically associated with alternative waterproofing products such as pinholes or delamination. The entire shower structure is protected by wedi's warranty: from bottom to top!



Using only a utility knife, wedi Building Panel is effortlessly cut and shaped.

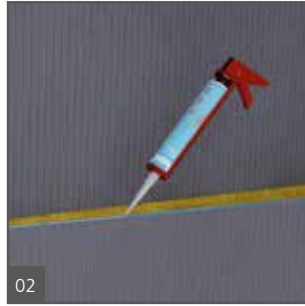

A continuous 10 mm bead of wedi Joint Sealant is applied on the foam edges of a wedi Building Panel before another panel is joined by butting tightly.



Apply 1 wedi fastener per every 300 mm, with an extra fastener applied directly in the seam to provide a flush transition between panels. On a ceiling, apply 1 wedi fastener per every 150 mm. The washer heads are dimpled below the surface of the wedi Building Panel so a flat surface is maintained.

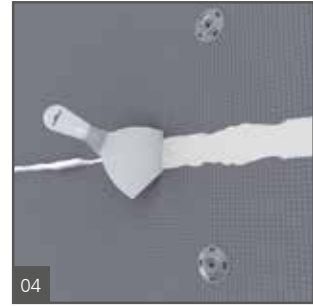

All excess wedi sealant is spread flat over all joints using a putty knife. Where needed, an extra bead of sealant is applied on top of the joints and spread flat. The joints should be covered a full 20 – 25 mm on both sides of the seam. Especially wedi joint sealant provides little build up making for square and tight corner areas perfect for tiling. All fastener locations are waterproofed using wedi Joint Sealant spread flat and widely over each washer.

## Tub Wall Surround Application

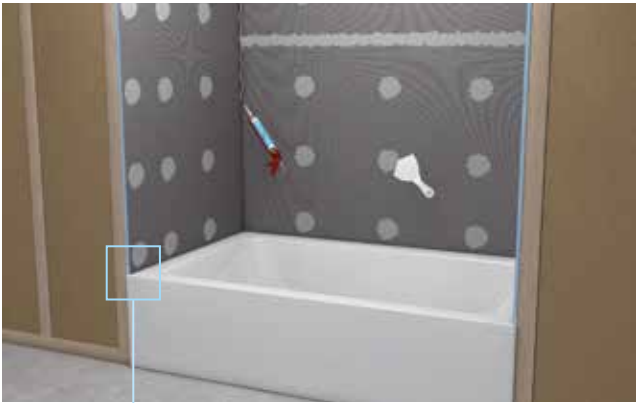

- 12,5 mm, 16 mm, and 20 mm are the recommended minimum thicknesses for installation to framing
- Wood Framing: 90 mm or 70 mm depth with maximum stud spacing 600 mm o.c.
- wedi 20 mm Building Panel or thicker can be used over 600 mm o.c. spaced wall framing
- wedi Waterproof Joint Sealant or wedi Sealing Tape to be applied over all seams and fastener heads if a waterproof installation is required
- wedi Joint Sealant or wedi Subliner Sealing Collars are used where plumbing protrusions must be sealed
- The Building Panel should be notched out at the bottom to install safely and plumb against the flange of the tub. A bead of wedi Joint Sealant is applied against the flange of the tub
- Attach wedi building panels with one fastener per every twelve inches and in between adjacent panels (seams) over wall framing
- On ceilings, use one fastener per every 150 mm and in between adjacent panels (seams)
- See the wedi Building Panel TDS for more detailed installation instructions by application on [wedi.com.au](http://wedi.com.au)

**!** Do not use mastic adhesives for setting tile over wedi product surfaces in wet area applications.





# Waterproof Shower System Solutions

## The modular wedi Shower System

wedi Shower floors and building panels are extremely lightweight yet they perform with extreme strength – thanks to the composition of their reinforced mortar resin surface coatings.

wedi shower floors can be covered with mosaic tiles or large format tiles. Mosaic tiles smaller than 50 mm square must be grouted using epoxy grout. Tiles larger than 100 mm square are cut along the slope lines of the wedi base to form grout lines where slope fields meet. There is no limitation to the type or size of tile or stone used. All cement or epoxy based thinsets mortars and grouts work with wedi products. Please do not use premixed, organic adhesives (Mastic) to set tile over wedi systems in wet areas.



## wedi Fundo Shower-Kits

wedi Fundo Primo Kit (point drain) and Fundo Riolito neo Kit (linear drain) are all you need to build a shower system ready for tile – just packed in one kit box! These systems are easy to install and blend the traditional values of design flexibility and robustness while offering the added benefits that come with state of the art material and manufacturing technologies. No more heavy mortar mixes, moisture in the mortar due to thinly or insufficiently applied, topical liquid waterproof membranes. Plus, reduce the traditional installation time and down times for a full shower floor preparation for tiling from 2 – 3 days to now 30 minutes.

## wedi Fundo Primo Kit

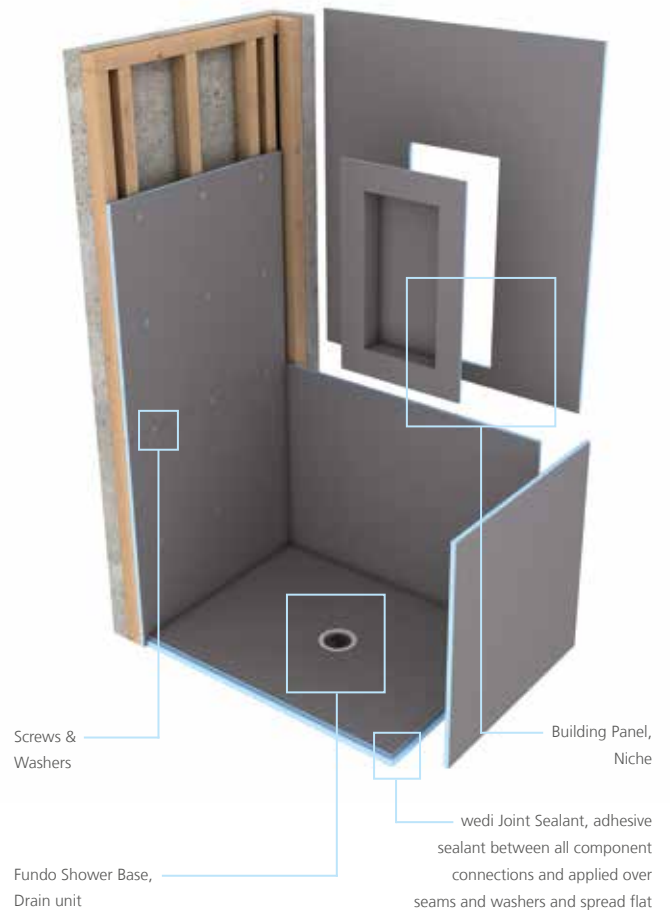



## The total shower solution

- All you need to build a shower system ready for tile in one Kit box – selectively with point or linear drain
- Entire System is 100% waterproof and mouldproof
- Very low weight, but extremely durable
- For a safe modular installation with option to field modify system components for custom tiled showers
- Installers and builders save time and money and are protected under wedi system warranty covering the entire shower substrate

## wedi Fundo Riolito neo Kit

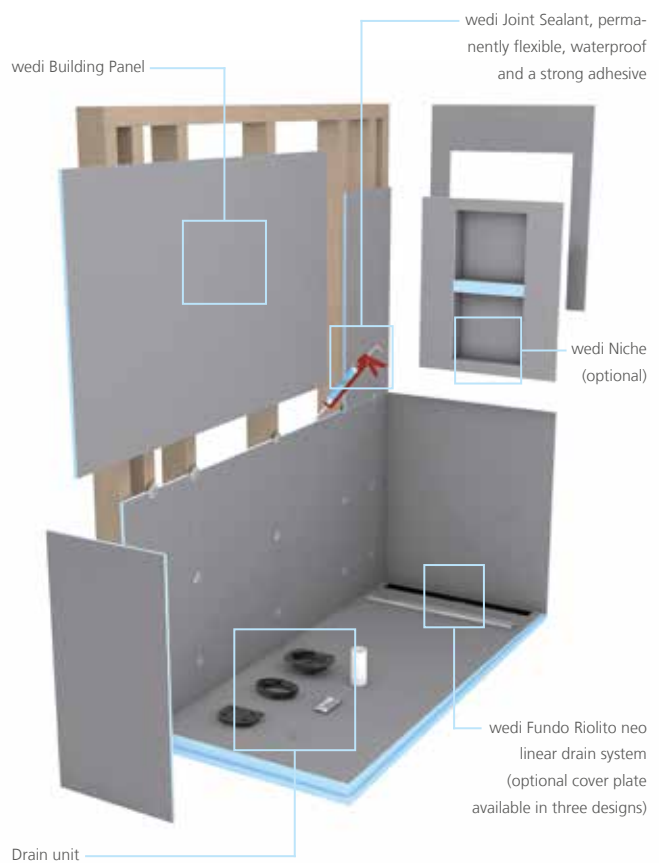

# wedi Fundo Primo

## Drain to Base Assembly

These added values and its detail perfections eliminate the technical concerns in shower installations. But this is not where wedi shower systems stop offering its added values: The wedi Fundo shower system adds to your productivity and enables you to provide real value to your customers: Our wedi Fundo Shower systems reduce the installation time for just the shower floor from a 2 day process (includes drying times) to only 30 minutes when compared to traditional methods built with mortar mix and topically applied liquid membrane. wedi helps you to turn showers into service quicker, cleaner, safer. Especially for our contractors, Fundo Primo helps to get to setting tile faster and on a much more consistent and tile friendly surface. Customers will appreciate the 'no noise and no dirt and dust' installation. The wedi products do not contain harmful ingredients providing peace of mind to contractors and end users.

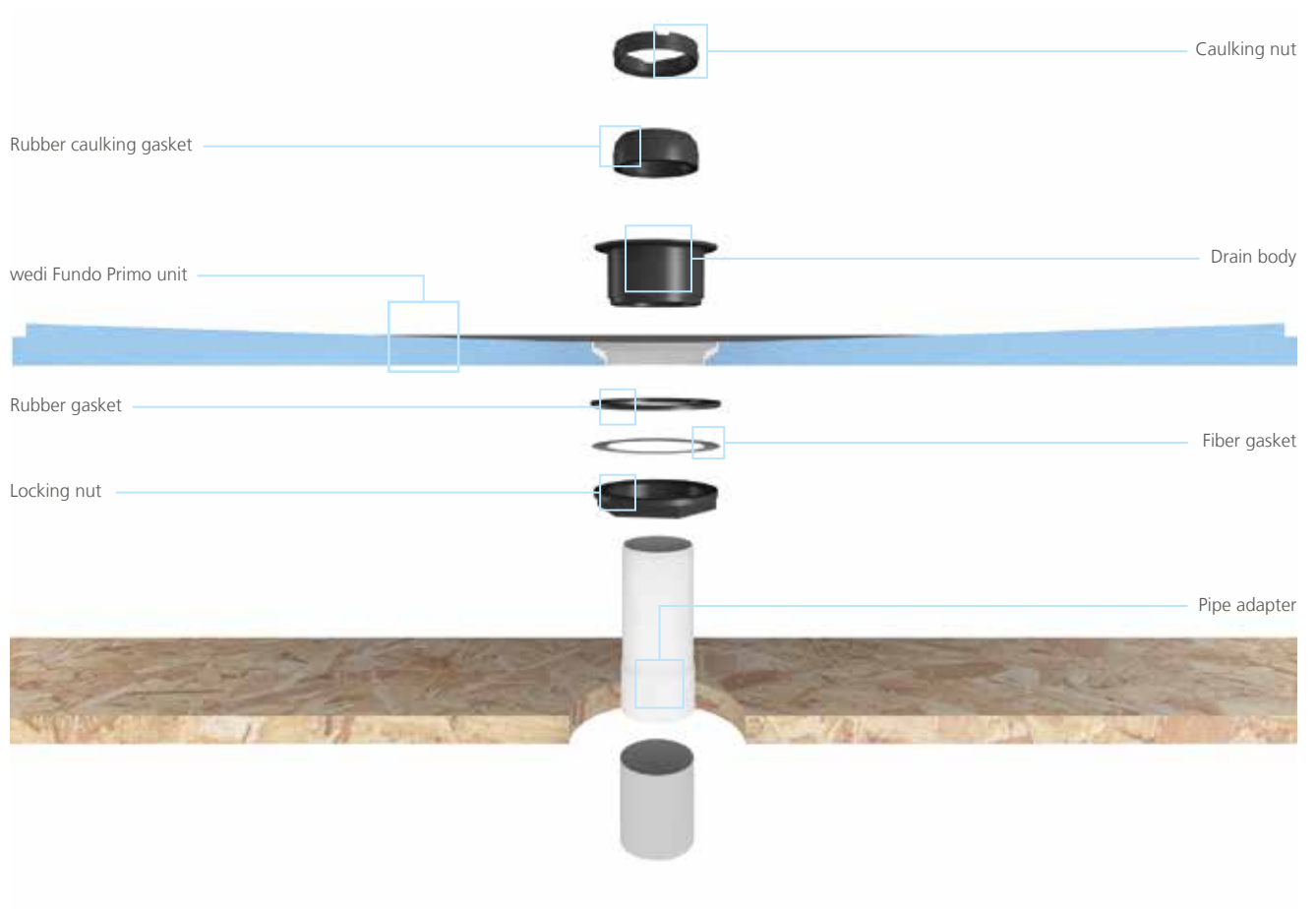

**!** Several Fundo Primo models naturally feature different perimeter height or thickness at the edge. Therefore, pre-made standard notch connections of wedi hobs must be modified in the field for a tight fit to the bases. Ramps and Extension panels can naturally not fit to all models and might be modified in the field as well.

## wedi Drain Cover Assembly / Insertion

Insert Cover frame into base hole (no glue/no screws). You may caulk between part and tile to create a flexible grout joint. The optional Extension Collar can be cut to height if part is needed. The caulk joint must not create a water barrier damming up the water draining through the thinset bed into the drain from below the tile. Therefore the thinset layer must be continuous toward the drain.

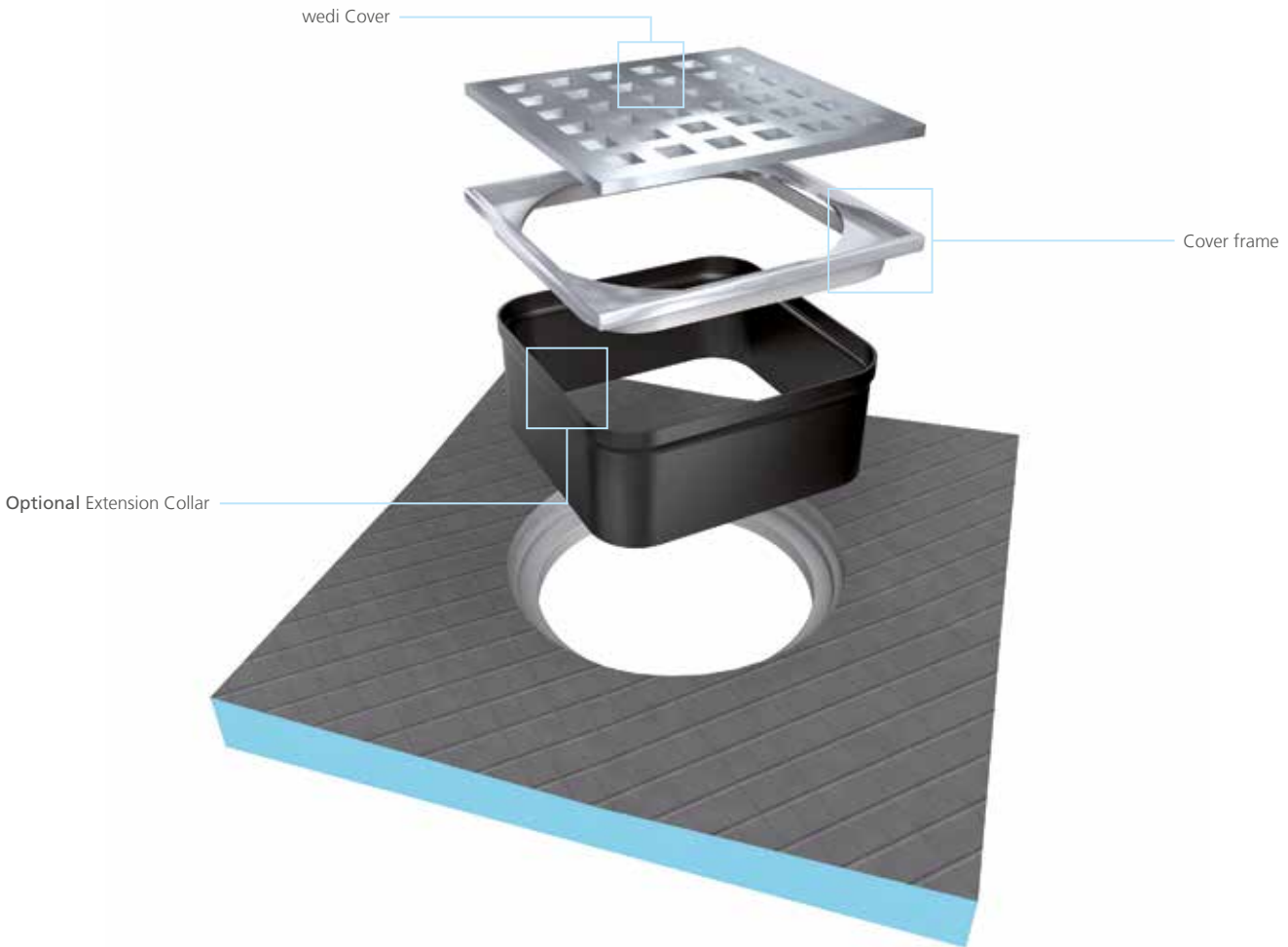

Fundo Fino Cover Set 1.1  
square (Daisy Design)



Fundo Fino Cover Set 1.1.2  
Round (Daisy Design)

**i** Please note: A Drain cover has to be purchased separately and can be found in various different designs at [www.wedi.com.au](http://www.wedi.com.au)



## wedi Fundo Primo Installation

### Before Installation:

- Subfloor and wall framing construction meets applicable building code and is sufficiently loadbearing, even and free of contaminants.
- Cut the DN 50 floor waste pipe using an inside pipe cutter at least 40 mm below the top of your substrate.
- Make sure you use a PVC Primer and Glue for the Drain Adapter.
- Only wedi products (Building Panels, Hob, wedi Joint Sealant and fasteners) are used for wedi Fundo Shower System assembly.
- Installer has received instructions from wedi technical sales staff or is informed about proper installation methods as described.
- wedi shower bases can be cut to size using a skilsaw. The Z notch channel must be remade and cleaned from sawdust or contaminants.



01

Cut the DN 50 floor waste pipe at least 40 mm below the top of the floor surface. Make sure that the cut out fits to the Fundo panel drain. Cut out a 130 mm diameter hole around the DN 50 pipe to allow the wedi drain to be inserted into the subfloor while the cut out area must remain free of deflection. Glue the Adapter to the DN50 Pipe so that the Adapter is sticking out of the subfloor.



02

Cut the Adapter flush to the floor construction. Make sure that the cut out fits to the Fundo panel drain.



03

Assemble the drain unit following the instruction drawing.



04

Set up a continuous 5 mm bead of wedi Joint Sealant along the channel in wedi Fundo's drain flange receptor.



05

Drop the drain body firmly into the sealant.



06

Turn the Fundo base upside down and apply the rubber and the fiber gasket. Tighten the gaskets firmly to the bases' steel ring using the locking nut. Make sure the drain body is still safely received in the valve-bead of sealant.



07

Trowel the thinset and comb through with a 10 x 10 mm notched trowel. Channels pointing to the entrance.



08 Press the Fundo firmly into the thinset bed, ensuring that the installation is level and void free. Apply some weight equally and for at least 30 minutes (thinset bags or tile boxes).



09 Set up the rubber caulking gasket (with the bevelled side up) around the 50 mm pipe in the subfloor. The rubber gasket must be flush with the upper end of the 50 mm ABS or PVC pipe.  
**Do Not use any Lubricants.**



10 Tighten (squeeze) the rubber caulking gasket firmly with the caulking nut (use a flat headed screwdriver) and finally insert the plastic frame and strainer on top (without adhesive). The frame and strainer will be held in a grout joint only once tiling commences.



11 Set up a continuous 10 mm bead of wedi Joint Sealant along the pans channel on the outer perimeter and only in areas where you can immediately install a building panel into the fresh sealant.



12 Push the wedi panel all the way into the channel of the shower base channel and its bead of sealant. Smooth out any pushed out sealant on inside seam using a putty knife. Fasten the panels directly to the studs starting 300 mm above the base and at a rate of 1 fastener per 300 mm. One extra fastener is set into the seam to the next panel to create a flush transition.



13 Apply continuous 10 mm beads of sealant between all connections of panels and install with tightly butted seams. Excess sealant must be spread flat with a putty knife. All seams and fastener heads in the assembly are covered with a secondary 10 mm bead of sealant and spread flat. The seams should be covered 25 mm on either side of seam. All fastener/washers are covered with sealant stretching 25 mm over the washer edges.



14 wedi Niches are installed in a cut out in the wedi wall and attached with it's flange right into the center of 450 mm studs. wedi Joint Sealant is set along the connection of wall to niche.



15 2 Fasteners each side of the niche are set to create a flush transition to the wall panels. Another 10 mm bead of wedi Joint Sealant is spread over fasteners and seams.



16 A continuous 10 mm bead of sealant is set into the channel and along the vertical hob notch part. A circle of 10 mm sealant bead is set against the wall panels where the hob attaches. A 10 x 10 mm notch trowel bed of thinset mortar is applied to the sub-floor and a skim coat on the bottom surface of the hob as a best practice. The tightly fitting hob is pressed into the connection area.

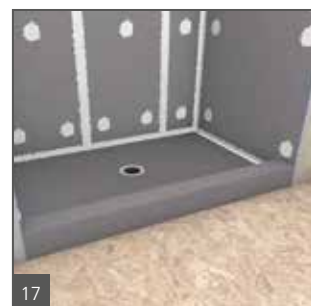

17 Weight is applied on and against the hob (from outside) and another 10 mm bead of sealant is applied over all hob seams and spread flat. The seams must be covered 25 mm either side of a seam.

**!** Hob connection notches must be cut to fit select Primo bases with perimeter thickness higher than 38 mm. For a fully waterproofed installation please install wedi sealing gaskets for mixing valve and shower head cut outs.

# wedi Fundo Ligno

## Drain to Base Assembly

wedi Fundo Ligno is designed to provide for a low profile base thickness of only 19 mm. This allows for a fast and flush installation into a subfloor assembly without cutting into floor joists. The system is designed to work without a hob. Enjoy the ease of installation without creating a structural hazard because you maintain the structural subfloor panels installed between floor joists under the wedi Fundo Ligno. Because barrier free showers may be exposed to heavy point loads (e.g. wheel chair), you can confidently rely on the structural strength of the wedi base and subfloor as well as the wedi Fundo's traditional strong cement based surface for ideal tile bond using any suitable cement based tile adhesives or grouts. As applied to all wedi Fundo Shower Systems, wedi Fundo Ligno is designed to interlock and work with wedi Building Panels, wedi Joint Sealant, wedi Fasteners, wedi Seats and Benches, wedi Niches and many more accessories, that truly complete your shower installation and waterproofing system. The installation is fast, modular but customisable, and covered by wedi's full system warranty.

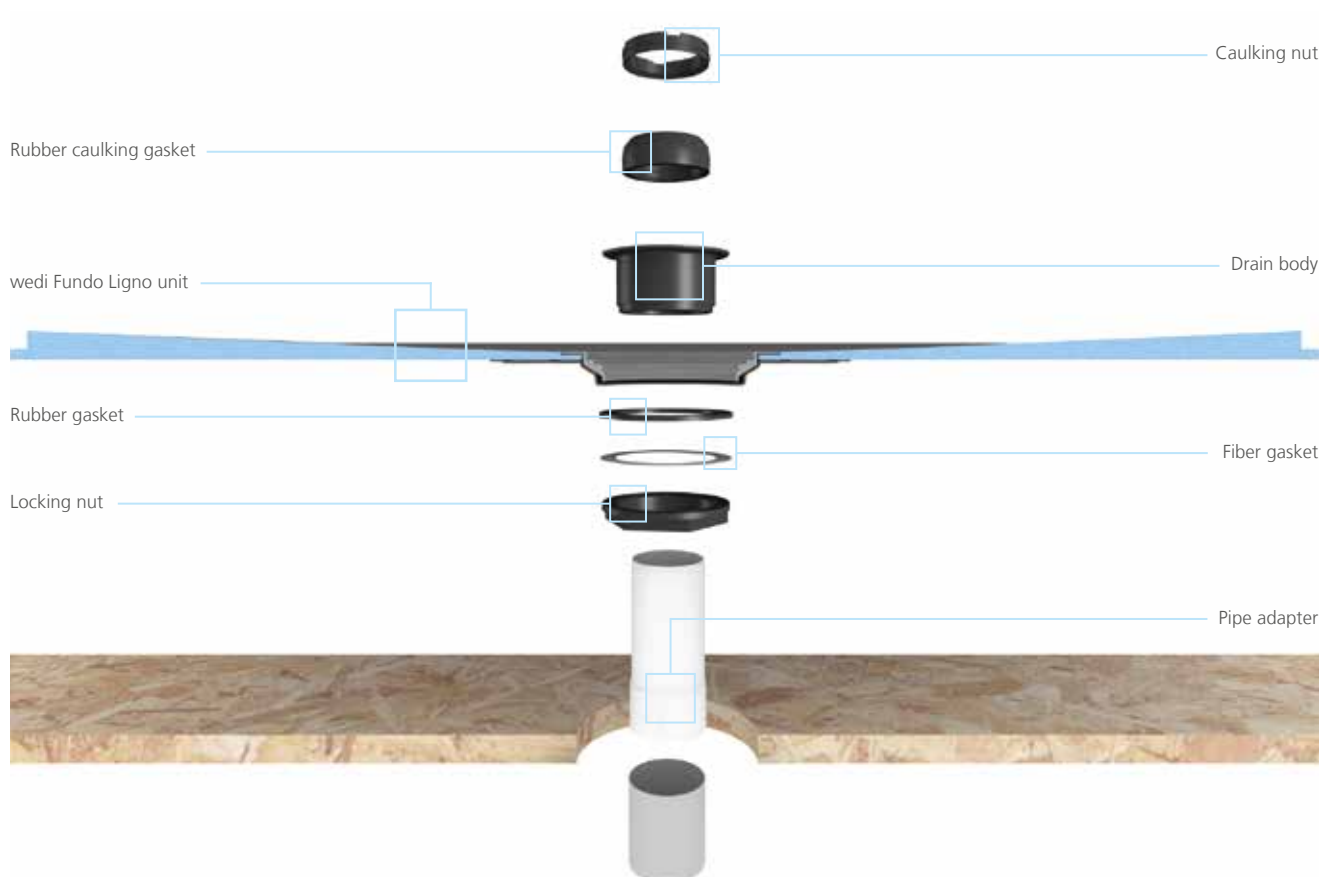





## wedi Fundo Ligno Installation

### Before Installation:

- Subfloor and wall framing construction meets applicable building code and is sufficiently loadbearing, even and free of contaminants.
- Cut the DN50 floor waste pipe using an inside pipe cutter minimum 56 mm below the current substrate.
- Make sure you use a PVC Primer and Glue for the Drain Adapter.
- Only wedi products (Building Panels, Hob, wedi Joint Sealant and fasteners) are used for wedi Fundo Shower System assembly.
- Installer has received instructions from wedi technical sales staff or is informed about proper installation methods as described.
- wedi shower bases can be cut to size using a skilsaw. The Z notch channel must be remade and cleaned from sawdust or contaminants.
- Do not cut the wedi Fundo Ligno more than 150 mm on either side and make sure your Z notch channels are never lower than 6 mm deep with a minimum 6 mm thick horizontal channel part remaining.



Cut 20 mm plywood base out fitting the space of wedi Fundo Ligno. Safely install blocking along floor joists apprx. 20 mm below top of floor joists. Adjust for thinset thickness under wedi Fundo Ligno base and/or the flooring underlayment installation adjacent to shower area to create a flush transition for waterproofing and tile between floor and shower area. Re-install 20 mm plywood over blocking to have the Plywood flush with the floor joists and fill with furring strips on top of floor joists in case the blocking/joist that carry the Plywood under wedi base is installed higher than 20 mm deep from top of floor joists. Make sure the entire perimeter of the wedi Fundo Ligno base is supported by floor joists or adequate blocking. Make sure the plywood base shows no seams where close to the cut out for the wedi Fundo Ligno drain. The DN50 pipe is cut square and even at minimum 56 mm below the recessed subfloor top surface. The pipe adapter is cut even at 16 mm below the recessed subfloor top surface.



Connect the wedi adapter to the floor pipe using the appropriate PVC cement glue. Make sure that the Pipe Adapter is cut even and square 16 mm below the recessed subfloor top surface. Make sure the round cut out in the floor allows for the full recess of the wedi drain body attached to the Fundo panel.



Assemble the drain unit following the instruction drawing.



04

Set up a continuous 5 mm bead of wedi Joint Sealant along the channel in wedi Fundo's drain flange receptor.



05

Drop the drain body firmly into the sealant.



06

Tighten the gaskets firmly to the bases' steel ring using the locking nut. Make sure the drain body is still safely received in the valve-bead of sealant.



07

Trowel the thinset and comb through with a 10 x 10 mm notched trowel. Channels pointing to the entrance.



08

Press the Fundo firmly into the thinset bed, ensuring that the installation is level and void free. Apply some weight equally and for at least 30 minutes (thinset bags or tile boxes).



09

Set up a continuous 10 mm bead of wedi Joint Sealant along the pans channel on the outer perimeter and only in areas where you can immediately install a building panel into the fresh sealant.



10

Push the wedi panel all the way into the channel of the shower base channel and its bead of sealant. Smooth out any pushed out sealant on inside seam using a putty knife. Fasten the panels directly to the studs starting 300 mm above the base and at a rate of 1 fastener per 300 mm. One extra fastener is set into the seam to the next panel to create a flush transition.

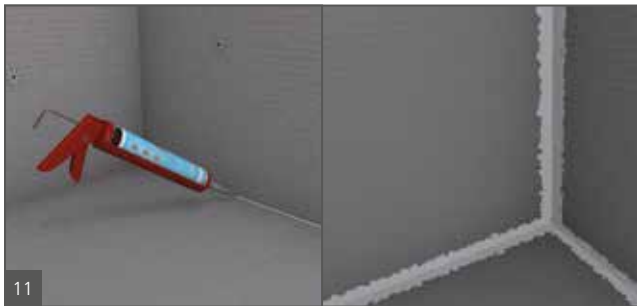

11

Apply continuous 10 mm beads of sealant between all connections of panels and install with tightly butted seams. Excess sealant must be spread flat with a putty knife. All seams and fastener heads in the assembly are covered with a secondary 10 mm bead of sealant and spread flat. The seams should be covered 25 mm on either side of seam. All fastener/washers are covered with sealant stretching 25 mm over the washer edges.

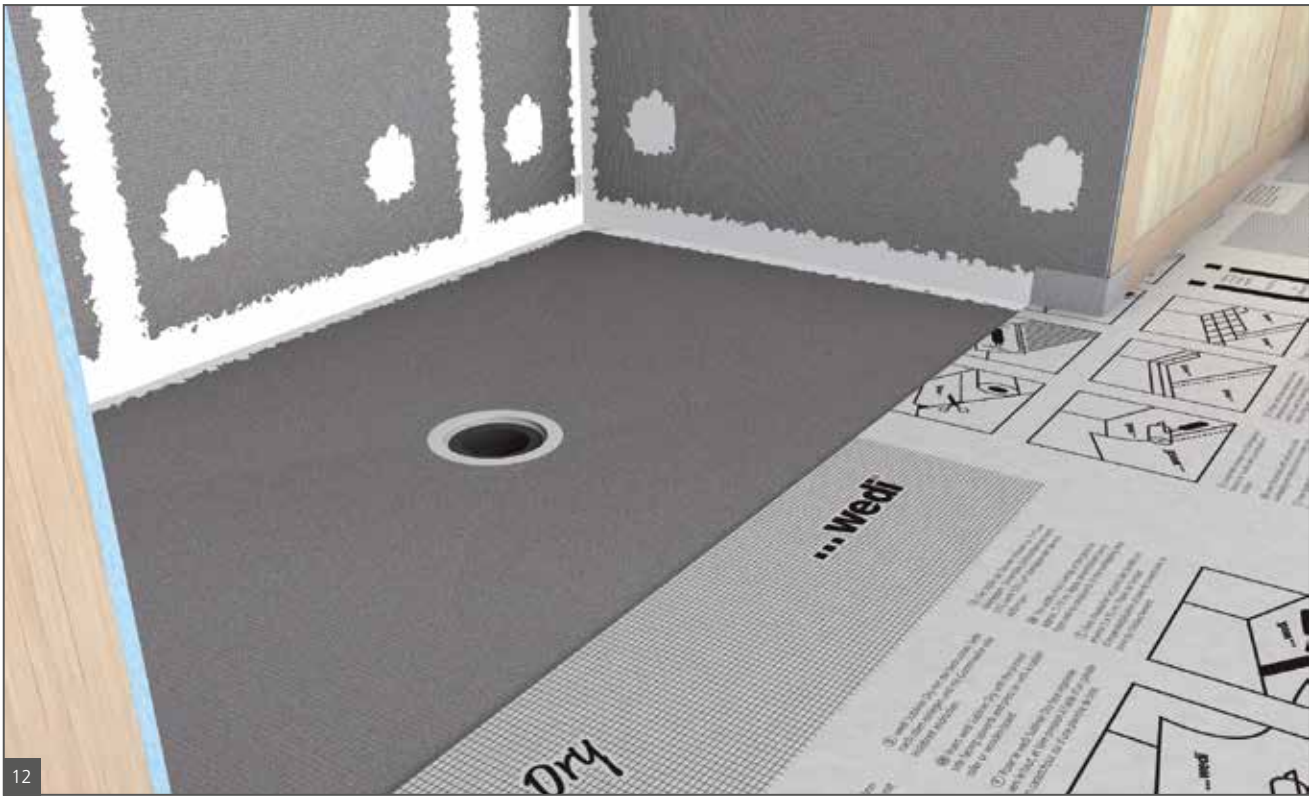

12

Apply a modified thinset across the wood or cement board floor surface and now apply wedi Subliner Dry Sheet waterproofing membrane overlapping into the Ligno base for 100 mm. Apply wedi's prefabricated outside or inside sealing tape corners and sealing tape as a flashing to the wedi wall panels/Ligno and Subliner dry sheets as applicable.

All seams and ends of the Subliner Dry sheets are covered with a 10 mm bead of wedi Joint Sealant and spread flat using a putty knife. Your shower is ready for tile once the thinset mortar has hardened! Alternatively to Subliner Dry sheet

membrane system wedi building panels in 6 or 10 mm thickness can be used as the floor tile underlayment in lieu of cement board and Subliner waterproofing. wedi Building Panel would be installed over plywood subfloor and overlap and seal into the Ligno channel. In such application the Ligno base must be raised to allow its channel to fully stick out from the recessed area so wedi floor building panels can be interlocked with its channel. All seams to wedi walls or Ligno base are sealed internally with wedi Joint Sealant, and are covered with an external 10 mm bead of wedi Joint Sealant spread flat. Your shower is ready for tiling once thinset under wedi Subliner Dry or wedi Building Panels on floor has cured.

**!** For a fully waterproofed installation please install wedi sealing gaskets for mixing valve and shower head cut outs.

# wedi Fundo Riolito neo Modular

## Linear Drain Shower Floor Solutions

wedi's Fundo Riolito neo System feature the only fully sealed and factory integrated waterproof drain assembly available in the market of customisable shower floor systems with linear drainage.

They are available in two design options. The first option includes models featuring a one-piece shower base including the drain trench. These provide 1-way or 4-way slopes. The second option, Riolito neo Modular is designed to offer more flexibility as it consists of two basic elements: one module including the line module which is a trench drain integrate in a wedi base module, the other being a sloped extension panel. Drainage can be installed close to the wall or two extension models leading away from either side of an i.e. centered drain. The line modules may also be used with mortar bed shower applications (to be typically waterproofed using wedi Subliner Dry, connecting to the Riolito neo line module).

Component 2:  
Fundo Riolito neo Extension  
Module – 100 % internally  
waterproof, mold proof,  
insulating wedi XPS closed  
cell foam core

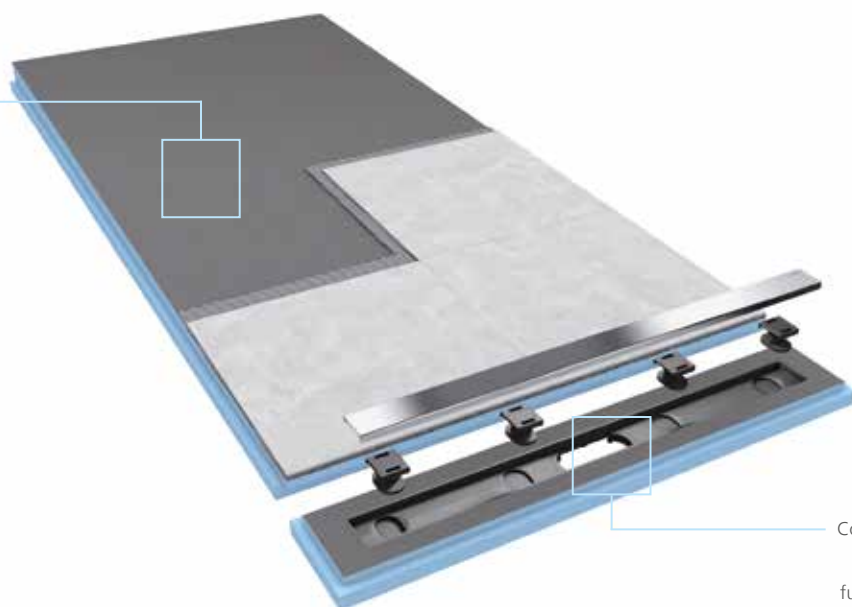

Component 1: Fundo Riolito  
neo Line Module – Multi-  
functional and customisable  
to the user's demands

# Drain to Base Assembly

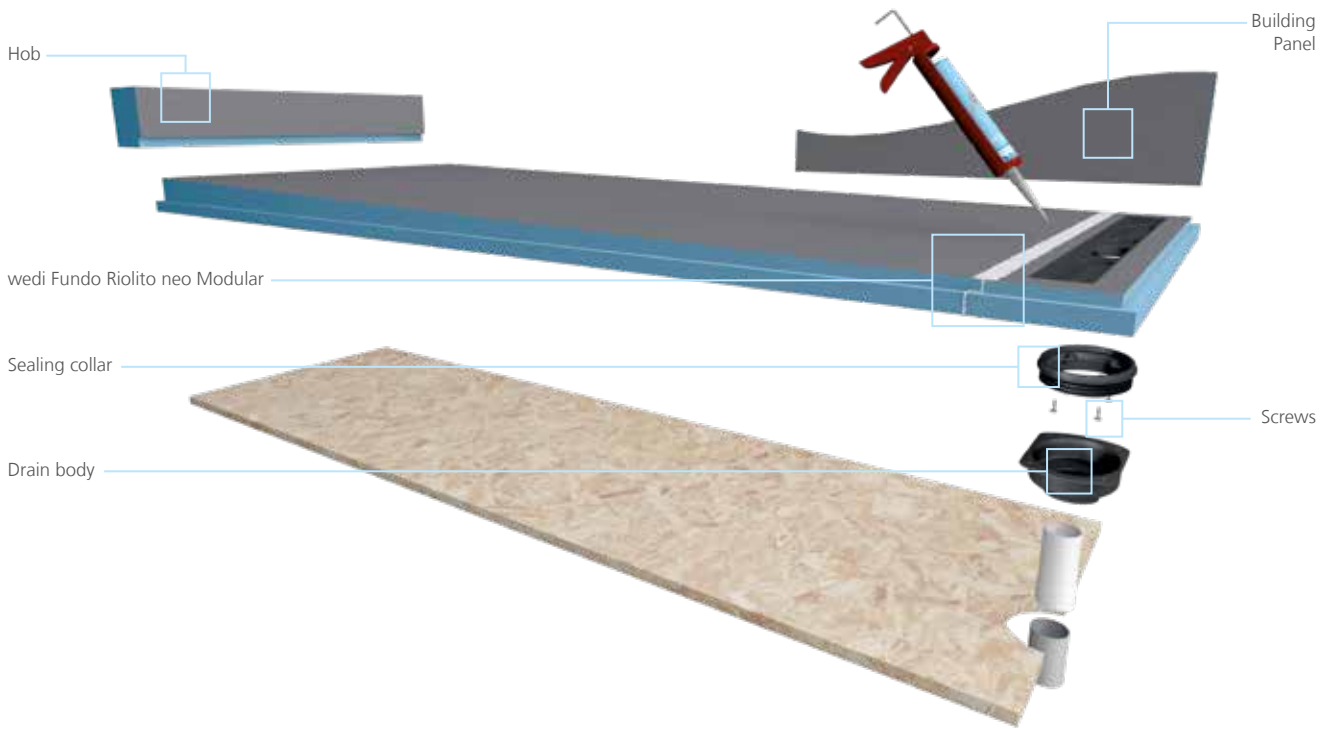

# wedi Fundo Riolito neo

## Linear Drain Shower Floor Solutions

wedi's pre-sloped shower bases Riolito neo feature fully factory sealed and integrated linear drainage systems. The base itself is naturally waterproof as well as mould proof, due to its closed cell XPS foam core. The Riolito neo bases come with the wedi typical strong and ready for tiling surface coating. All Riolito neo shower bases can be field modified.

They can be cut to size or extended using wedi's pre-sloped Fundo extensions. The integrated drain in Riolito neo ensures your installation is not exposed to the risk commonly associated with bonding flange design/surface waterproofing installation-type, single drain products. The unique wedi Fundo Riolito neo bases allow water to drain away through a narrow gap between their drains cover plate and the tile surface finish. wedi Fundo Riolito neo is always equipped with the drain unit but covers are ordered separately. Options for covers include a polished stainless steel version, a double plated brushed stainless steel version, and a tileable version.

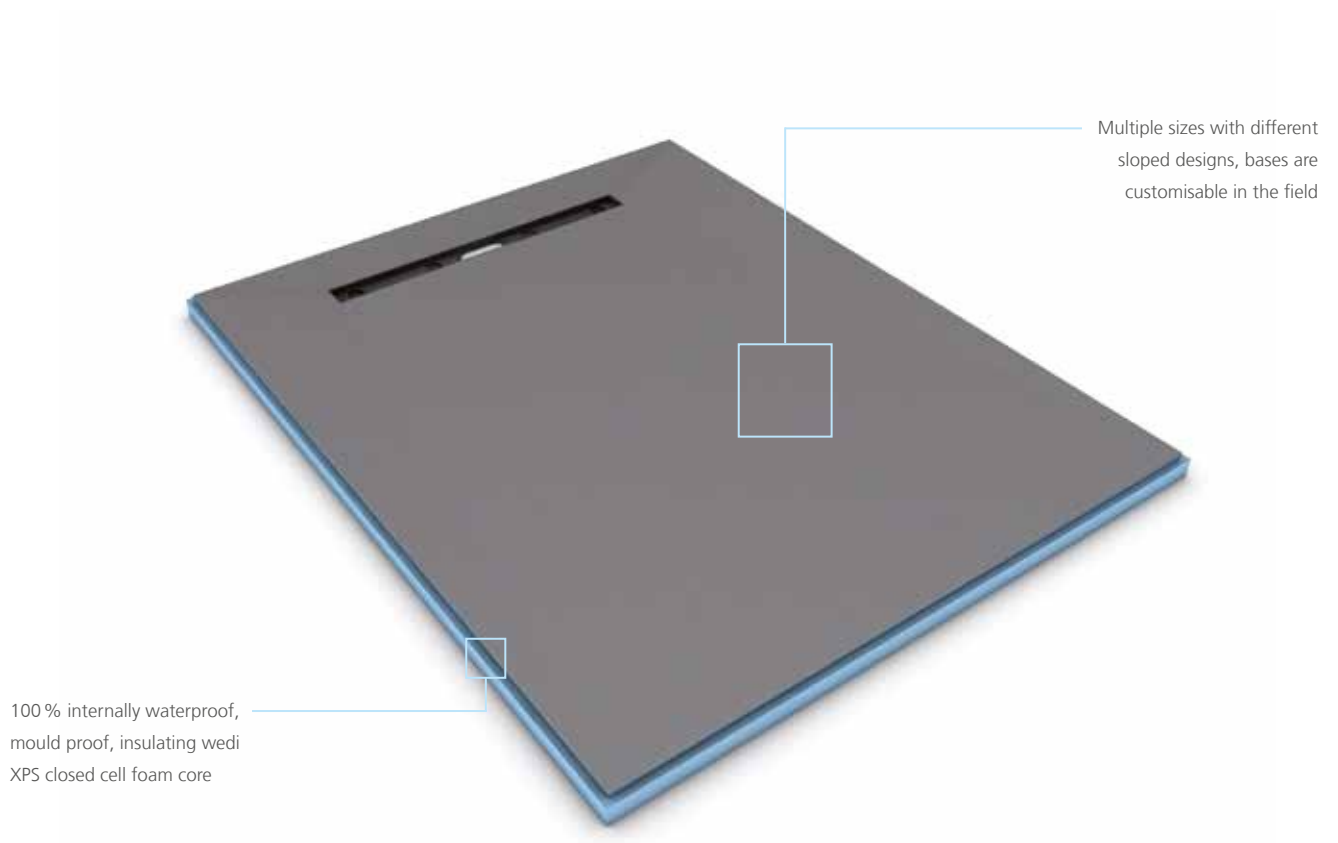

## Drain to Base Assembly

Several models with 4 way slope fields provide for a perfect installation when recessing the base into a subfloor where a flush to the floor entry is required. The second option includes models with a true one way slope towards the linear drain. This latter option is especially designed to accommodate tub to shower conversions without the need to ever move the floor drain pipe.

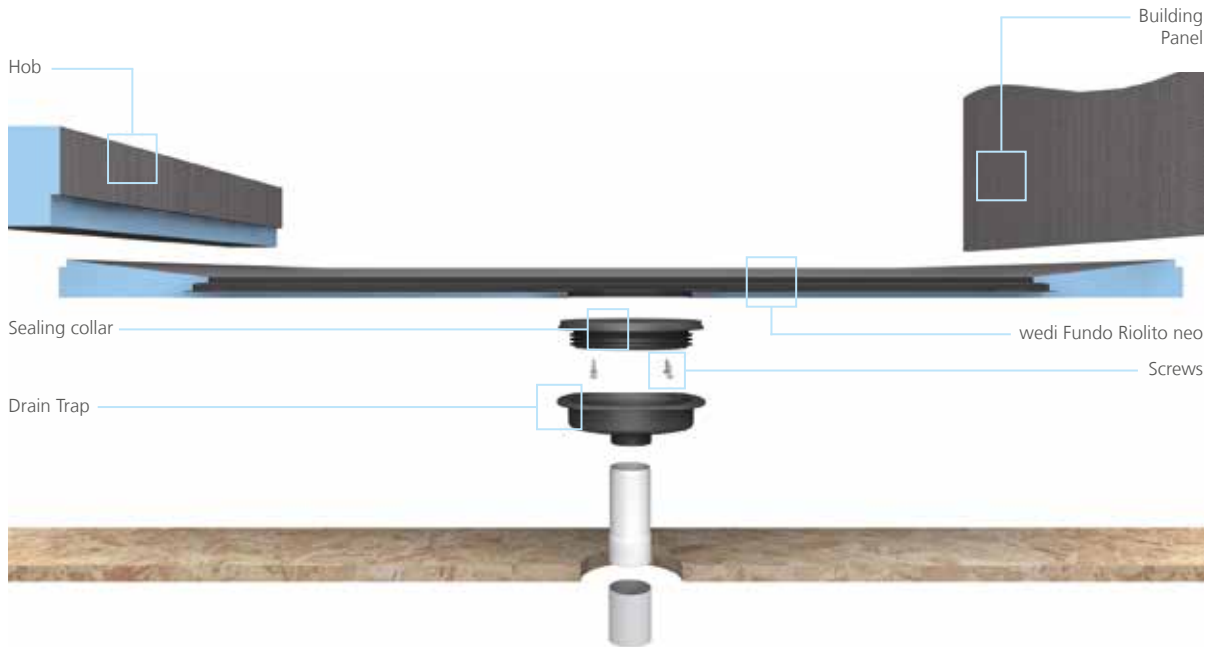

**!** Fundo Riolito neo employs different drain and drain cover assembly parts. Please refer to the installation manual in the actual product box.

In this section Fundo Riolito neo we are showing the Fundo Riolito neo Drain and Drain Cover parts and assembly.

Several Riolito neo models naturally feature different perimeter height or thickness at the edge. Therefore, pre-made standard notch connections of wedi hobs must be modified in the field for a tight fit to the bases. Ramps and Extension panels can naturally not fit to all models and might be modified in the field as well.



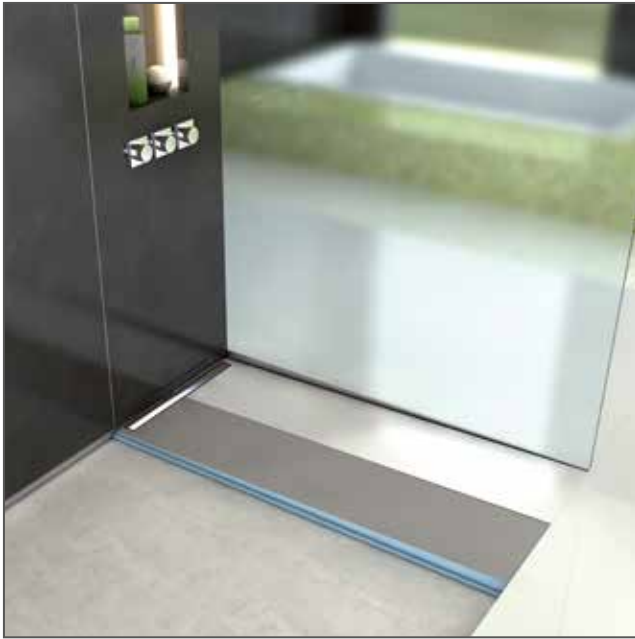

## wedi Fundo Riolito neo Installation

### Before Installation:

- Subfloor and wall framing construction meets applicable building code and is sufficiently loadbearing, even and free of contaminants.
- Cut the DN 50 Floor waste pipe minimum 70 mm below the top of the floor surface.
- To have the Type N solvent cement primer and glue for our ABS drain trap
- Make sure to use a PVC primer and glue for the Adapter.
- Only wedi products (Building Panels, Hob, wedi Joint Sealant and fasteners) are used for wedi Fundo Shower System assembly.
- Installer has received instructions from wedi technical sales staff or is informed about proper installation methods as described.
- wedi shower bases can be cut to size using a skilsaw. The Z notch channel must be remade and cleaned from sawdust or contaminants.



01

Cut DN 50 pipe minimum 70 mm below the top of the Subfloor. Use the oval shape cutting template to cut subfloor using a jigsaw. Position the oval template according to the position of the Riolito model's predetermined position of its drain location, relative to the squared wall framing...



02

... to allow wedi drain trap to be inserted and connected to floor pipe using appropriate ABS compatible or multipurpose cement glue. Please also check cement glue compatibility to floor pipe material. The drain and trap have to be secured to the subfloor. Drain recess cut out must not add deflection to subfloor.



03

Cut the Adapter 32 mm below the subfloor surface. Make sure that the cut out fits to the Fundo panel drain.



04

Assemble the drain unit following the instruction drawing. wedi's Riolito neo bases can be cut to size on all sides making drain positions close to the wall possible. Please do not cut into the linear drains plastic flange integrated into the coated foam part of the base. If you are using a 12.5 mm wedi Building Panel, the channel at the new base perimeter must be reestablished to 12.5 x 12.5 mm. When cutting close to the drain channel always leave enough wedi foam for re-making the needed 10 x 10 mm channel.





05  
Glue and seal the wedi drain trap to the DN 50 pipe. Mount the sealing collar to the wedi Riolito neo underside counterpart using a manual phillips screwdriver.



06  
Apply a skim coat and finally a combed bed of a thinset using modified thinset and a 10 x 10 mm notch trowel.



07  
Press the Fundo firmly into the thinset bed, ensuring that the installation is level and void free. Ensure wedi drain's sealing gasket is firmly inserted in the wedi trap with no chance that thinset could have pushed into this connection area. Apply some weight equally and for at least 30 minutes (thinset bags).



08  
Set up a continuous 10 mm bead of wedi Joint Sealant at the perimeter channel and only in areas where you can immediately install a wedi Building Panel into the fresh sealant.



09  
Push the wedi panel all the way into the channel of the shower base channel and its bead of sealant. Smooth out any pushed out sealant on inside seam using a putty knife. Fasten the panels directly to the studs starting 300 mm above the base and at a rate of 1 fastener per 300 mm. One extra fastener is set into the seam to the next panel to create a flush transition.



10  
Apply continuous 10 mm beads of sealant between all connections of panels and install with tightly butted seams. Excess sealant must be spread flat with a putty knife. All seams and fastener heads in the assembly are covered with a secondary 10 mm bead of sealant and spread flat. The seams should be covered to 25 mm on either side of seam. All fastener/washers are covered with sealant stretching 25 mm over the washer edges.



11  
wedi Niches are installed in a cut out in the wedi wall and attached with it's flange right into the center of 16 o.c. studs. wedi sealant is set along the connection of wall to niche.



12  
2 Fasteners each side of the niche are set to create a flush transition to the wall panels. Another 10 mm bead of wedi sealant is spread over fasteners and seams.



13  
A continuous 10 mm bead of sealant is set into the channel and along the vertical hob notch part. A circle of 10 mm sealant bead is set against the wall panels where the hob attaches. A 10 x 10 mm bed of thinset mortar is applied to the subfloor and just a skimcoat on the foam bottom part of the hob as a best practice. The tightly cut to fit hob is pressed into the connection. Weight is applied on and against the hob (from outside) and another 10 mm bead of sealant is applied over all hob seams and spread flat. The seams must be covered 20 – 25 mm either side of a seam.

**!** Hob connection notches must be cut to fit select Riolito neo bases with perimeter thickness higher than 40 mm. For a fully waterproofed installation please install wedi sealing gaskets for mixing valve and shower head cut outs.

## After Installation

All bottom perimeter joints, hob joints, vertical and horizontal panel joints are visibly covered with wedi Joint Sealant. Coverage should be continuously visible for at least 18.5 mm to 25 mm on each side of the joint. No mastic adhesives are to be used to install tile in wedi Shower Systems. Ceramic tiles smaller than 50 x 50 mm must be grouted using epoxy grout. River Rock or Pebble Stones must be grouted with a modified cementitious sanded grout. Large format tile can be used on wedi Fundo bases. The tiles must be cut where the slope fields meet unless a single slope model is used. When complete wedi Shower System is installed with wedi Joint Sealant, a water flood test may be performed only 2 hours after final application of wedi Joint Sealant (application temperature must be ambient / interior with normal relative humidity and temperatures above 40°F).

## Installation instructions wedi Fundo Riolito neo Drain Cover

01 Drain Cover Fundo Riolito neo standard: High Grade Polished Stainless Steel Standard Version

02 Drain Cover Fundo Riolito neo exclusive: High Grade Double Plated Stainless Steel Version

03 Drain Cover Fundo Riolito neo tileable: Can be tiled with epoxy glue/adhesive. Can be used for 6 and 10 mm tile / stone (reverse cover) Drain cover can be adjusted from + 5 mm to + 25 mm from Riolito neo base surface. Adjusting feet/cover supports can be extended or cut to size.



## Linear channel cover standard and exclusive

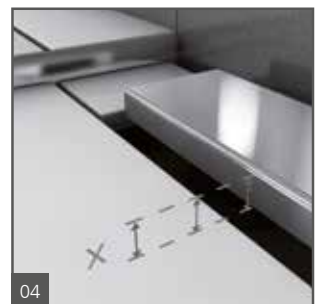
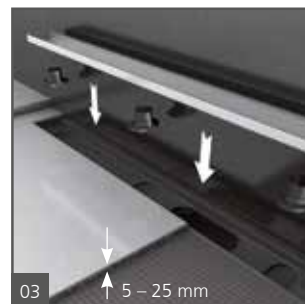



### Linear channel cover tileable

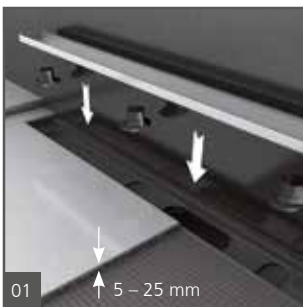

# wedi Sanoasa

## wedi Sanoasa benches 1–4

Comfort means something different to each person. The feeling of quiet and relaxation when sitting in the shower, though, is a very pleasant experience for everyone. The wedi Sanoasa benches provide plenty of space to comfortably relax, pampering both your body and mind in your own small wellness temple.

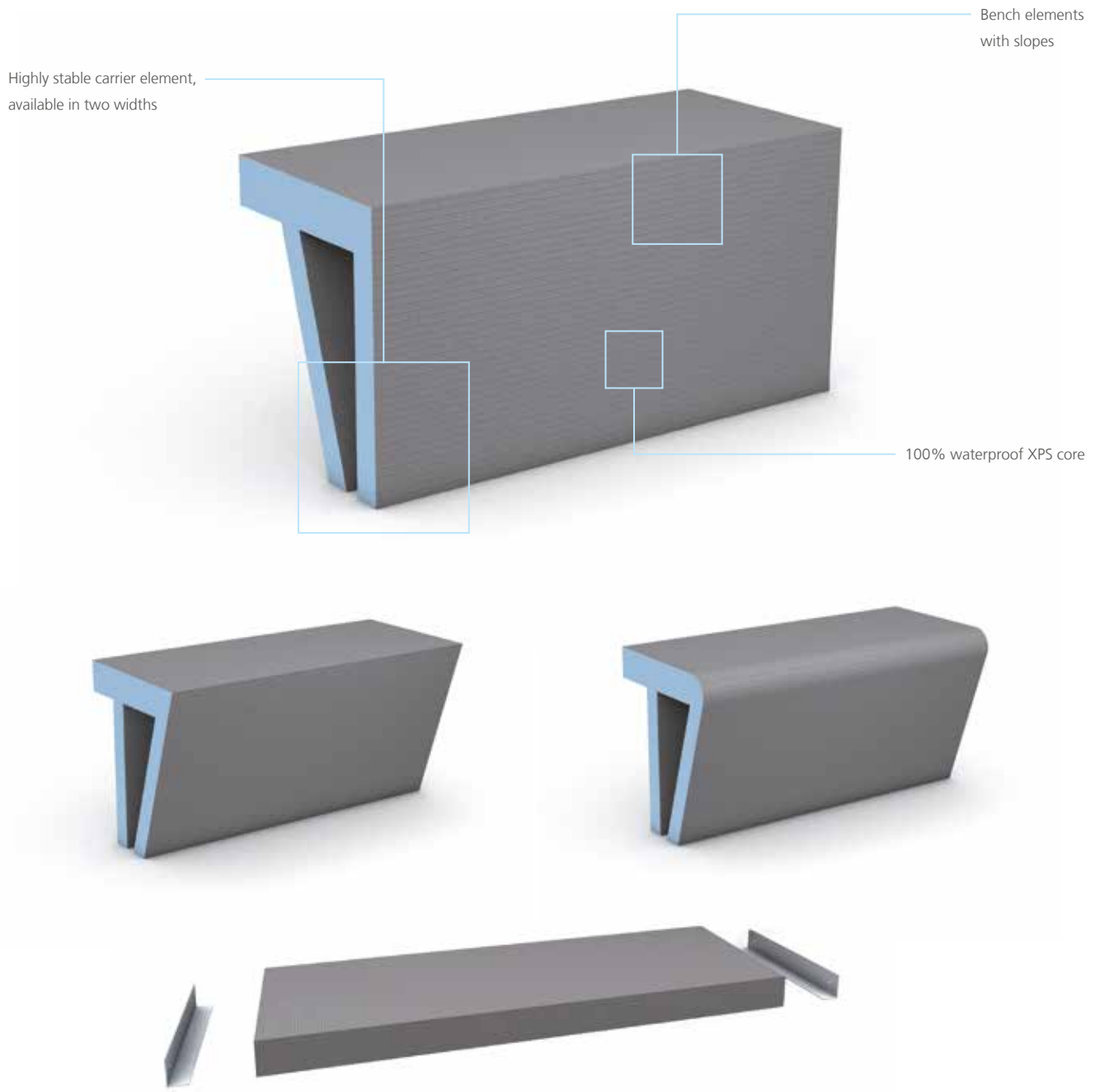

## wedi Sanoasa corner seat

Fine detail with a strong impact. The new corner seat in a pure triangular shape is available in two sizes and invites you to a relaxing wellness break in the shower.

Very strong: handles loads up to 150 kg

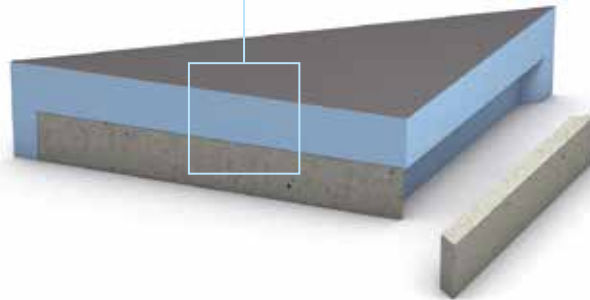

---

## wedi Sanoasa loungers

The Sanoasa loungers stand out due to their original and unique shapes. They set individual accents in wellness areas in a variety of styles and designs and can be harmoniously integrated into the total room concept. Colours and formats can be combined to produce unique designs. Combined with an integrated heating system (hot water heating or electric heating) so that there is nothing to prevent total relaxation.



wedi Sanoasa Lounger 1



wedi Sanoasa Lounger 2



wedi Sanoasa Lounger 3



wedi Sanoasa Lounger 4



wedi Sanoasa Lounger 5

# wedi niche solutions

## wedi niches

wedi niche solutions are practical but at the same time aesthetically pleasing. Their spacious design highlights their luxurious character in the bathroom and also provides convenient shelf space. Particularly in small guest bathrooms, they offer extra space for a variety of shower components or personal decorative touches.

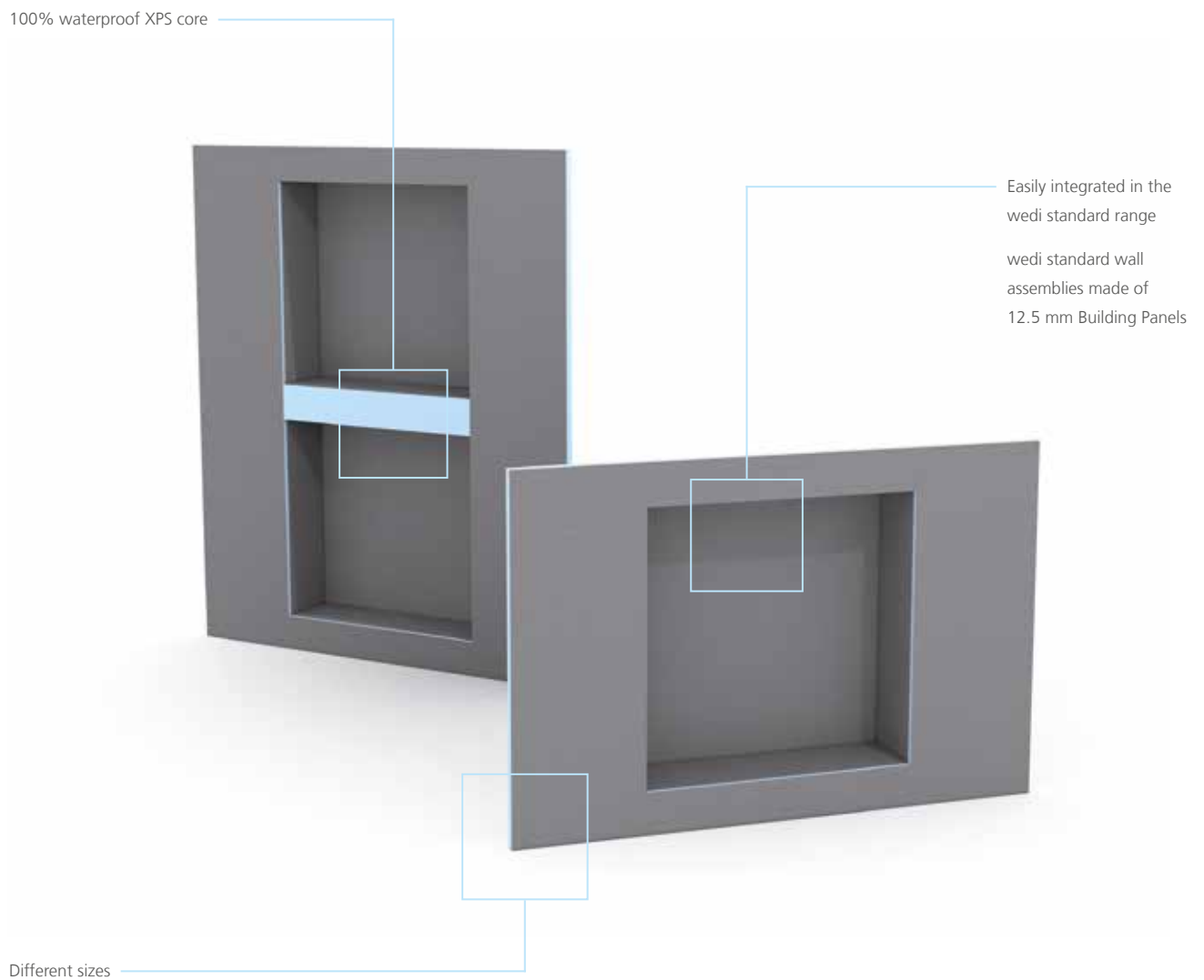

wedi Niche 70, square, 305 × 305 × 80 mm

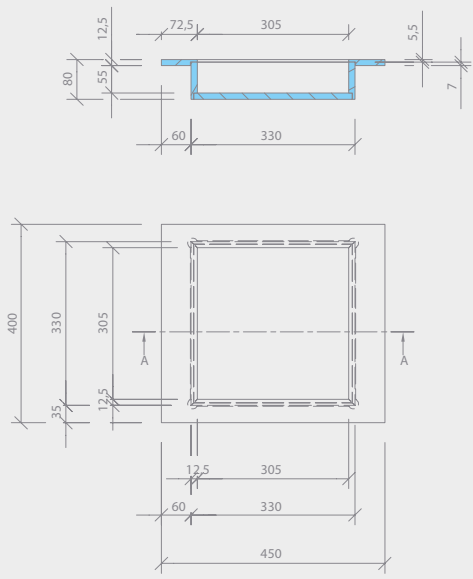

wedi Niche 70, rectangular, 305 × 610 × 80 mm

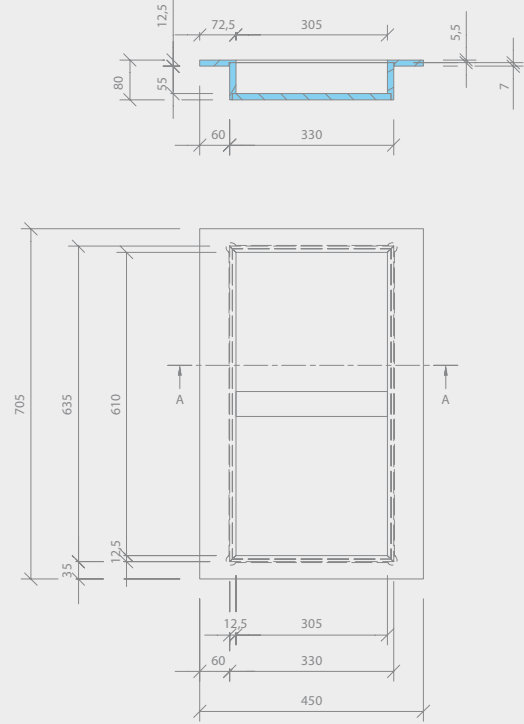

wedi Niche 90, square, 305 × 305 × 100 mm

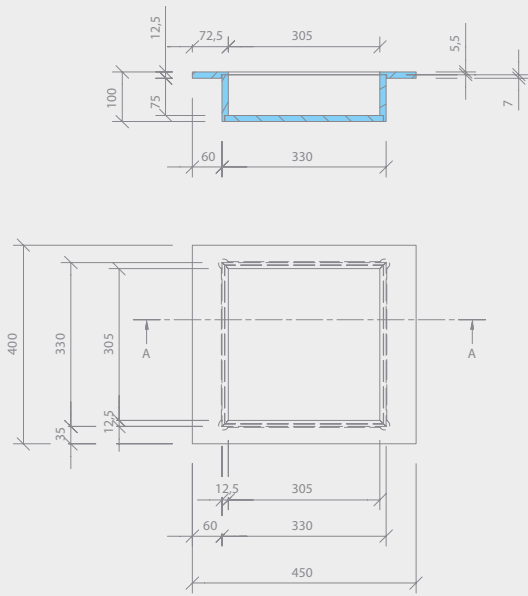

wedi Niche 90, rectangular, 305 × 610 × 100 mm

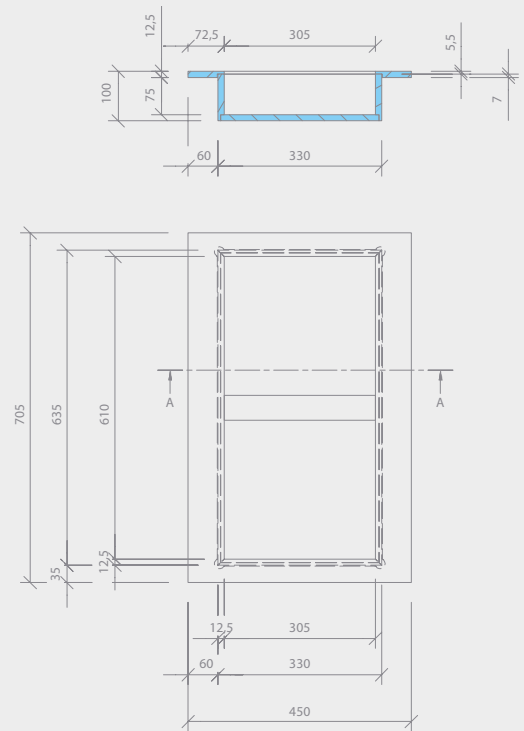



## System configuration for shower solution systems with benches

### Products used

- 1 [wedi Fundo Riolito neo](#) ▪ the flush to floor shower element with close-to-wall linear drainage
- 2 [wedi Sanoasa bench 1](#) ▪ bench, straight
- 3 [wedi Fundo Riolito Discreto](#) ▪ the visual wall drain, in this case, integrated in the carrier element of the bench
- 4 [wedi building boards](#) ▪ as free-standing partition wall and for the cladding of wall surfaces
- 5 [wedi Joint Sealant](#) ▪ Permanently flexible, waterproof MS polymer sealant and adhesive for joint treatment

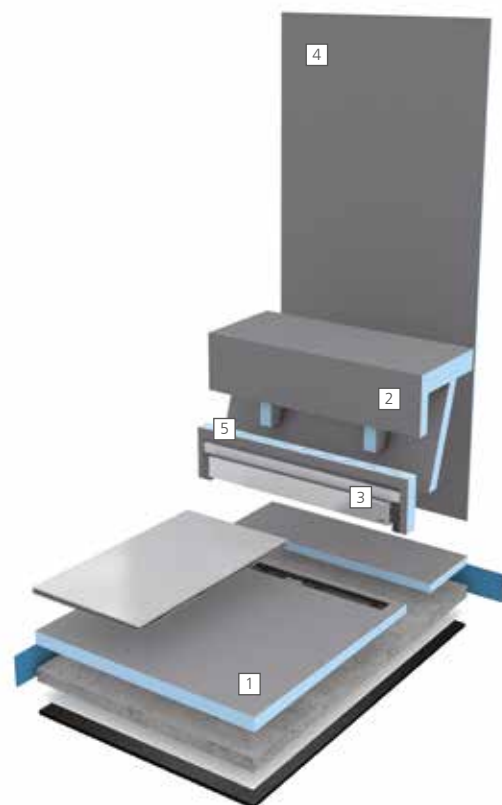



## Construction variations of the wedi Sanoasa bench 1–3

The clever construction of the wedi Sanoasa bench enables an unequalled freedom of visual design; both the seating areas and the carrier elements can not only be positioned the way you like, but also their shapes and sizes can be modified to suit.

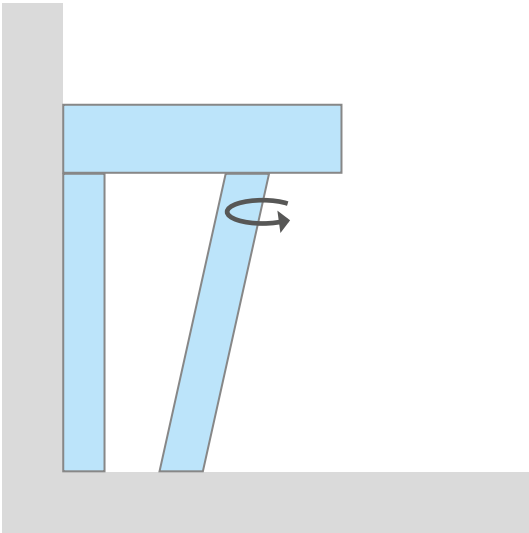

Base can be positioned freely

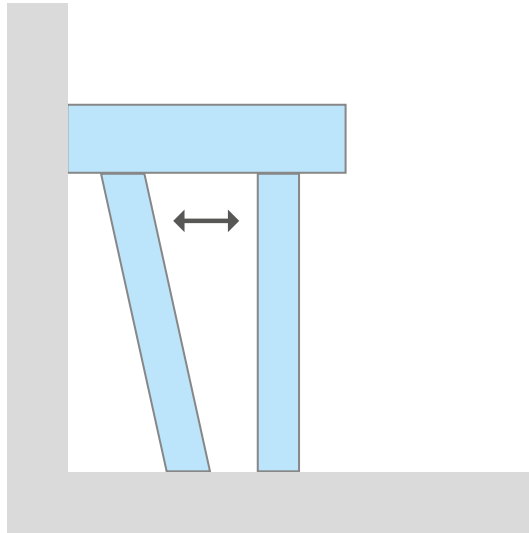

Seating area can be shortened for different configurations

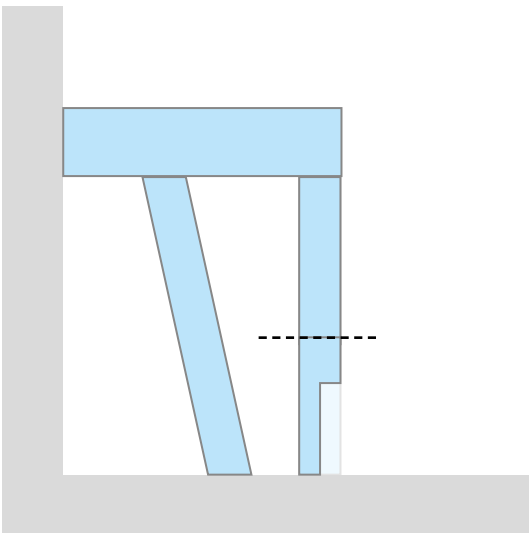

1-cut Discreto Installation The front element can be modified for integration of the Fundo Riolito Discreto wall drain

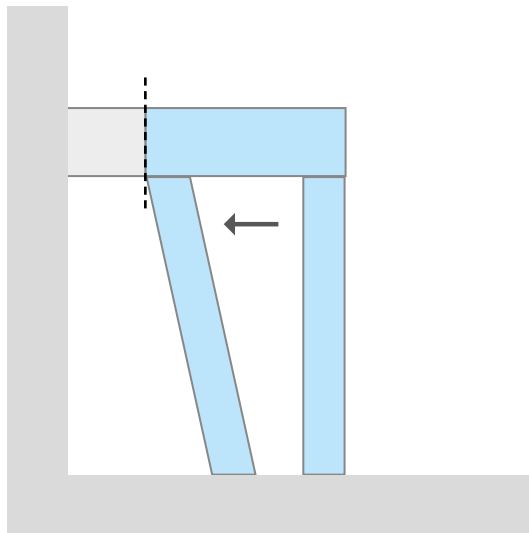

Seating can be shortened to different variations

# wedi Subliner

## wedi Subliner Dry Sheet Membrane

The wedi Subliner Dry System includes Subliner Dry Sheet Membrane, Sealing Tape, Prefabricated Outside and Inside Corner Tapes as well as various Sealing Collars to waterproof entire structures in especially shower and steam room construction. wedi Subliner Dry is well suited for sealing measures over preexisting wall or floor underlayment including drywall. Use Subliner Dry in combination with ceramic tiles, slabs, and natural cast tiles for indoor wall and floor areas. Especially strong performance in steam showers/rooms due to its unique Vapor Resistance rating of 0.09 WVTR/Perms as tested using ASTM E96, method E. The Subliner Dry is a strong membrane yet very pliable. Installation steps and measuring and cutting gridlines are printed on its surface for fast working.

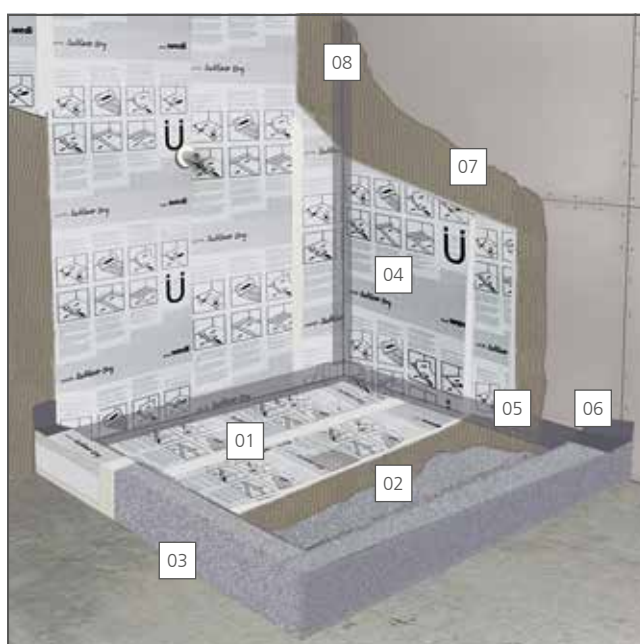

### Installation Over Mortar Bed Showers/ On Walls and Shower Floor

- |   |                            |
|---|----------------------------|
| 01 wedi Joint Sealant   | 05 Inside Corner Seal      |
| 02 wedi Subliner Dry  | 06 Outside Corner Seal     |
| 03 Mortar bed structure with hob  | 07 modified thinset mortar |
| 04 Subliner Dry membrane in modified thinset mortar attached to primed drywall construction | 08 Sealing Tape            |



## Subliner Dry

Installation on Floors or other suitable, non waterproof underlayments



01

Lay out wedi Subliner Dry and cut to size using a knife or scissors.

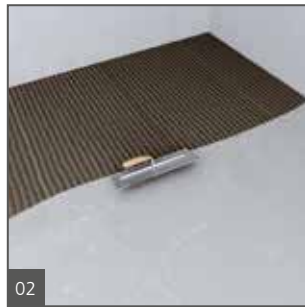

02

Apply thinset mortar to the prepared subfloor using a 3×3 mm or 10×10 mm notch trowel.



03

Insert wedi Subliner Dry with the printed side facing upward and press on with a rubber roller or wooden float.

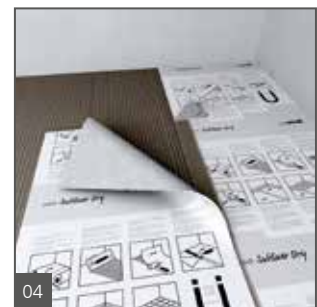

04

The sheets must overlap 50 mm at joints/transitions. Apply a bed of thinset mortar with the flat side of the trowel onto the lower mat joint connection area and press flat.



05

Press on the overlapping area with a trowel or rubber roller. Remove any escaping mortar and air pockets. Cross joints should be avoided.



06

Apply a continuous 10 mm bead of wedi Joint Sealant along all seams and spread flat with a putty knife over the joints.

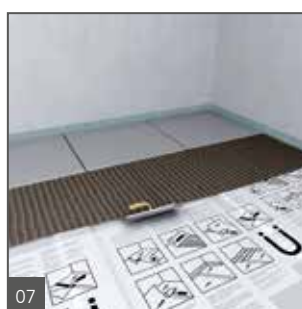

07

Start setting tile once the thinset mortar under Subliner Dry has sufficiently cured.

## wedi Building Panel





Description	Length × Width × Thickness	Unit/Palette	Item #
wedi Building Panel	1250 × 600 × 4 mm	136 panels = 102 m <sup>2</sup>	010000004
wedi Building Panel	1524 × 914 × 6 mm	50 panels = 69 m <sup>2</sup>	010718006
wedi Building Panel	1524 × 914 × 12.7 mm	50 panels = 69 m <sup>2</sup>	010717064
wedi Building Panel	1524 × 914 × 16 mm	50 panels = 69 m <sup>2</sup>	010716316
wedi Building Panel	2500 × 600 × 20 mm	50 panels = 75 m <sup>2</sup>	010000020
wedi Building Panel	2500 × 600 × 40 mm	36 panels = 54 m <sup>2</sup>	010000040
wedi Building Panel	2500 × 600 × 50 mm	24 panels = 36 m <sup>2</sup>	010000050

## wedi Building Panel XL & XXL

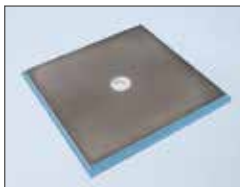

Description	Width × Length × Thickness	Unit/Palette	Item #
wedi Building Panel XL	2500 × 900 × 12.7 mm	26 panels = 58.5 m <sup>2</sup>	010000912
wedi Building Panel XXL	2600 × 1200 × 10 mm	26 panels = 81.12 m <sup>2</sup>	010729410
wedi Building Panel XXL	2600 × 1200 × 12.7 mm	26 panels = 81.12 m <sup>2</sup>	010001612
wedi Building Panel XXL	2500 × 1200 × 20 mm	26 panels = 79 m <sup>2</sup>	010001220
wedi Building Panel XXL	2500 × 1200 × 50 mm	12 panels = 36 m <sup>2</sup>	010001250

## wedi Fundo Primo | Square and Rectangular Shower Bases, Center Drain

Description	Dimensions	Unit	Item #
wedi Fundo Primo, square	914 × 914 mm	1 pc	073735507
wedi Fundo Primo, square	1220 × 1220 mm	1 pc	073735505
wedi Fundo Primo, square	1524 × 1524 mm	1 pc	073735518
wedi Fundo Primo, square	1830 × 1830 mm	1 pc	073735524
wedi Fundo Primo, rectangular	914 × 1220 mm	1 pc	073735516
wedi Fundo Primo, rectangular	914 × 1524 mm	1 pc	073735506
wedi Fundo Primo, rectangular	1220 × 1524 mm	1 pc	073735509
wedi Fundo Primo, rectangular	1220 × 1830 mm	1 pc	073735508
wedi Fundo Primo, rectangular	1524 × 1830 mm	1 pc	073735519
wedi Fundo Primo, rectangular	1220 × 2134 mm	1 pc	073735522
wedi Fundo Primo, rectangular	1524 × 2134 mm	1 pc	073735523
wedi Fundo Primo, rectangular	914 × 1830 mm	1 pc	073735525

**!** wedi Fundo elements vary in thickness from 38 to 50 mm at the perimeter. When working with modular wedi hobs or ramps the connection notch might need to be adjusted in the field.



Please do not forget to purchase separately the Drain Assembly Kit and the Drain Cover.



Bases are slightly oversized to allow for trimming to nominal sizes in the field.

## wedi Fundo Primo | Rectangular Shower Base, Offset Drain

	Description	Dimensions	Unit	Item #
	wedi Fundo Primo, rectangular, offset drain	914 x 1830 mm incl. drain	1 pc	073735521
<p><b>!</b> For tub replacement installations. Cut unit to always meet drain and shower size.</p>				

## wedi Fundo Primo Shower Kit

	Description	Dimension	Unit	Item #
	wedi Fundo Primo Shower Kit	914 x 914 mm center drain	1 pc	US2000002
	wedi Fundo Primo Shower Kit	914 x 1220 mm center drain	1 pc	US2000007
	wedi Fundo Primo Shower Kit	1220 x 1220 mm center drain	1 pc	US2000004
	wedi Fundo Primo Shower Kit	914 x 1524 mm center drain	1 pc	US2000003
	wedi Fundo Primo Shower Kit	914 x 1830 mm center drain	1 pc	US2000001
	wedi Fundo Primo Shower Kit	914 x 1830 mm offset drain	1 pc	US2000008
	wedi Fundo Primo Shower Kit	1220 x 1524 mm center drain	1 pc	US2000005
	wedi Fundo Primo Shower Kit	1220 x 1830 mm center drain	1 pc	US2000006

- 
  - 1 wedi Fundo Pan
  - wedi Building Panels to cover up to (3) 2000 mm walls
  - 1 drain assembly
  - wedi Joint Sealant
  - fasteners
- 
  - wedi putty knife
  - Includes wedi installation DVD
  - Includes wedi Fundo standard Stainless Steel Cover / Frame
- !**
  - Wall height 2000 mm

## wedi Fundo Ligno | Square and Rectangular Shower Bases, Center Drain

	Description	Dimensions	Unit	Item #
	wedi Fundo Ligno, square	1220 x 1220 x 19 mm	1 pc	073732015
	wedi Fundo Ligno, square	1524 x 1524 x 19 mm	1 pc	073732018
	wedi Fundo Ligno, rectangular	914 x 1220 x 19 mm	1 pc	073732014
	wedi Fundo Ligno, rectangular	914 x 1524 x 19 mm	1 pc	073732016
	wedi Fundo Ligno, rectangular	1220 x 1524 x 19 mm	1 pc	073732017

## wedi Fundo Primo and Ligno Drain Kit

	Description	Unit	Item #
	wedi Fundo Primo and Ligno Drain Kit	1 pc	US1000040

## wedi Fundo | wedi Fundo/Pre-Sloped Extension Panels

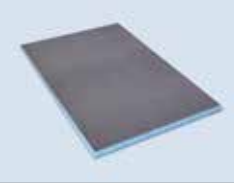
	Description	Width × Length × Thickness	Unit	Item #
	wedi Shower Base Extension	610 × 1220 mm, sloped 6.35/300 mm	sheet	073783528
	wedi Shower Base Extension Lean	305 × 1830 mm, sloped 6.35/300 mm	sheet	073783523
	wedi Ligno Extension Panel	305 × 1524 mm, sloped 6.35/300 mm	sheet	073732030

- ! ▪ Slope extends over 610 or 305 mm direction of either extension panel and pre-grooved
- Extension panels are designed to interlock with Fundo Primo bases and 4 way slope Fundo Riolito neo bases. The installation height must be increased if connected to Fundo and Ligno shower bases thicker than 38.1 mm at perimeter.

## wedi Fundo Standard | Drain Cover, Stainless Steel Base

	Description	Width × Length	Unit	Item #
	wedi Fundo Drain Cover Set, Brushed Stainless Steel	100 × 100 mm	1 pc	US1000009
	wedi Fundo Drain Cover Set, Brushed Stainless Steel with Screws	100 × 100 mm	1 pc	US1000029
	wedi Fundo Drain Cover Set, Oil Rubbed Bronze	100 × 100 mm	1 pc	US1000008

- ! ▪ For this drain cover, the height of your tiling must be at least 6.35 mm.
- For use with wedi Fundo Primo, Ligno, Trollo, Nautilo bases.
- 👉 ▪ 1 drain cover, stainless steel
- 1 frame

## wedi Fundo Fino | Optional Design Covers, Stainless Steel Brushed

	Description	Unit	Item #
	wedi Fundo Fino Cover Set 1.1, square (Daisy Design)	1 pc	US1000021
	wedi Fundo Fino Cover Set 1.1.2, Round (Daisy Design)	1 pc	US1000023
	wedi Fundo Fino Cover Set 1.3, square w. Screws (Daisy Design)	1 pc	US1000022
	wedi Fundo Fino Cover Set 1.3.2, Round/w. Screws (Daisy Design)	1 pc	US1000027
	wedi Fundo Fino Tileable Cover Plate, square	1 pc	US1000020

- ! ▪ For use with wedi Fundo Primo, Ligno, Trollo, Nautilo bases.
- Tileable cover plate surface is elevated 2 mm over tile surface of a Fundo base. For a flush tile installation, wedi joint sealant spot bonding may be used to install the tile inside the cover so height is reduced versus the thinset bed build up under the tile on the shower base.
- 👉 ▪ 1 drain cover, stainless steel
- 1 Frame, stainless steel



## wedi Fundo Riolito neo | Shower Base, with Integrated Channel Drain

	Description	External Dimensions Length × Width × Height	Channel Length	Item #
	wedi Fundo Riolito neo, floor base, with channel drain	914 × 1524 × 51 mm incl. drain, four-way slope	1100 mm	075100016
wedi Fundo Riolito neo, floor base, with channel drain	1220 × 1524 × 63 mm incl. drain, four-way slope	700 mm	075100012	
wedi Fundo Riolito neo, floor base, with channel drain	1220 × 1830 × 51 mm incl. drain, four-way slope	1100 mm	075100014	
wedi Fundo Riolito neo, floor base, with channel drain	813 × 1830 × (63 – 34 mm) incl. drain, single slope (one-way slope)	700 mm	075100015	
wedi Fundo Riolito neo, floor base, with channel drain	813 × 1830 × 63 mm incl. drain, two-way slope, drain 305 mm offset	700 mm	075100035	

## wedi Fundo Riolito neo Modular | Shower Base, with Integrated Channel Drain

	Description	External Dimensions Length × Width × Height	Channel Length	Item #
	wedi Fundo Riolito neo Modular, line module	813 × 146 mm	700 mm	075100052
wedi Fundo Riolito neo Modular, line module	1220 × 146 mm	1100 mm	075100053	
wedi Fundo Riolito neo Modular, extension module	813 × 1700 mm	–	075100050	
wedi Fundo Riolito neo Modular, extension module	1220 × 1700 mm	–	075100051	

## wedi Fundo Riolito neo Shower Kit

	Description	Dimension	Unit	Item #
	wedi Fundo Riolito neo Shower Kit	813 × 1830 mm One-Sided Slope	1 pc	US4000010
	<ul style="list-style-type: none"> <li>! Wall height 2000 mm</li> <li>Order drain cover separately</li> </ul>	<ul style="list-style-type: none"> <li>! 1 wedi Fundo Shower Pan</li> <li>wedi building Panels to cover up to (3) 2000 mm walls</li> <li>1 drain assembly</li> <li>Fasteners</li> <li>wedi Joint Sealant</li> </ul>		

## wedi Fundo Riolito Drain Kit



Description	Unit	Item #
wedi Fundo Riolito Drain Kit	1 pc	US1000042

## wedi Fundo Riolito Standard | Cover Plate, Stainless Steel



Description	Width × Length × Height	Unit	Item #
wedi Fundo Riolito Standard drain cover for 914 × 1524 mm and 1220 × 1830 mm Riolito base	41 × 1100 × 19 mm	1 pc	676797045
wedi Fundo Riolito Standard drain cover for 1220 × 1524 mm and 813 × 1830 mm Riolito base	41 × 700 × 19 mm	1 pc	676797048

⚠ For tile installation heights of between 4.8 to 25 mm

## wedi Fundo Riolito Exclusive | Cover Plate, Stainless Steel



Description	Width × Length × Height	Unit	Item #
wedi Fundo Riolito Exclusive drain cover for 914 × 1524 mm and 1220 × 1830 mm Riolito base	41 × 1100 × 19 mm	1 pc	676797046
wedi Fundo Riolito Exclusive drain cover for 1220 × 1524 mm and 813 × 1830 mm Riolito base	41 × 700 × 19 mm	1 pc	676797049

⚠ For tile installation heights of between 4.8 to 25 mm

## wedi Fundo Riolito Tileable | Cover Plate, Stainless Steel



Description	Width × Length × Height	Unit	Item #
wedi Fundo Riolito Tileable drain cover for 914 × 1524 mm and 1220 × 1830 mm Riolito base	41 × 1100 × 19 mm	1 pc	676797047
wedi Fundo Riolito Tileable drain cover for 1220 × 1524 mm and 813 × 1830 mm Riolito base	41 × 700 × 19 mm	1 pc	676797050

⚠ For tile installation heights of between 4.8 to 25 mm.  
Reverse for thinner or thicker tile.



## wedi Fundo Discreto | System Component, for Creating Vertical Wall Drainage

	Description	External Dimensions Length × Width × Height	Unit	Item #
	wedi Fundo Discreto System Component Integrates into wedi seats, tileable cover included	800 × 50 mm	1 pc	073738200

**i** For installation over wedi Fundo Riolito 1220 × 1524 mm or 813 × 1524 mm bases

## wedi | Full Foam Hob

	Description	Width × Length × Height	Unit	Item #
	wedi Hob Full Foam (Square Edges)	115 × 914 × 130 mm	1 pc	US3000011
	wedi Hob Full Foam (Square Edges)	115 × 1524 × 130 mm	1 pc	074319002
	wedi Hob Full Foam (Square Edges)	115 × 2500 × 130 mm	1 pc	074319001

**!** Sloped on top surface

## wedi | Hob Full Foam “LEAN”

	Description	Width × Length × Height	Unit	Item #
	wedi Hob Full Foam “LEAN” (Square Edges)	50 × 1524 × 90 mm	1 pc	074319007
	wedi Hob Full Foam “LEAN” (Square Edges)	50 × 2500 × 90 mm	1 pc	074319008

**!** Sloped on top surface

## wedi Shower Ramp

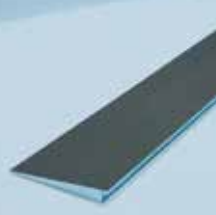
	Description	Width × Length × Height	Unit	Item #
	wedi Shower Ramp*	305 × 1524 mm, sloped 38.1 to 6.35 mm	1 pc	073736517

**!** \* ADA compliant

## wedi Niche | rectangular

	Description	Inside Dimensions Width × Height × Depth	Unit	Item #
	wedi Niche 70, square	305 × 305 × 80 mm	1 pc	US3000020
	wedi Niche 70, rectangular	305 × 610 × 80 mm	1 pc	US3000022
	wedi Niche 90, square	305 × 305 × 100 mm	1 pc	US3000021
	wedi Niche 90, rectangular	305 × 610 × 100 mm	1 pc	US3000023

## wedi Shower Seat M&L

	Description	Width×Length × Height	Unit	Item #
	wedi Seat M, Suspended Seat	432 × 432 (wall sides) × 100 mm	1 pc	US3000001
	wedi Seat L, Suspended Seat	610 × 610 (wall sides) × 100 mm	1 pc	US3000002

## wedi Bench | Rectangular and Full Foam Triangular Seats

	Description	Width × Length × Height	Unit	Item #
	wedi Bench, Rectangular	406 × 813 × 508 mm sloped	1 pc	073784100
	wedi Full Foam Corner Seat	584 × 584 (wall sides) × 508 mm sloped	1 pc	073784101

**!** Rectangular bench made with 51 mm wedi Building Panel, full foam corner seat made of solid XPS foam. These units are pre-made and ready for thinset installation against walls and feature a 3 mm slope to the front.

## wedi Sanoasa Bench 1

	Description	Length × Height × Depth	Unit	Item #
	wedi Sanoasa Bench 1 M	900 × 454 × 380 mm	1 pc	076447030
	wedi Sanoasa Bench 1 L	1200 × 454 × 380 mm	1 pc	076447031

**!** The bench is delivered in four parts: Bench element, substructure element and 2 side elements

- wedi Joint Sealant is included for adhesion
- wedi Fiberglass Mesh Tape is included for the wall/floor connection

## wedi Sanoasa Bench 2

	Description	Length × Height × Depth	Unit	Item #
	wedi Sanoasa Bench 2 M	900 × 454 × 380 mm	1 pc	076447032
	wedi Sanoasa Bench 2 L	1200 × 454 × 380 mm	1 pc	076447033

**!** The bench is delivered in four parts: Bench element, substructure element and 2 side elements

- wedi Joint Sealant is included for adhesion
- wedi Fiberglass Mesh Tape is included for the wall/floor connection

## wedi Sanoasa Bench 3

	Description	Length × Height × Depth	Unit	Item #
	wedi Sanoasa Bench 3 M	900 × 454 × 380 mm	1 pc	076447034
	wedi Sanoasa Bench 3 L	1200 × 454 × 380 mm	1 pc	076447035

**!** The bench is delivered in four parts: Bench element, substructure element and 2 side elements

- wedi Joint Sealant is included for adhesion
- wedi Fiberglass Mesh Tape is included for the wall/floor connection

## wedi Sanoasa Bench 4

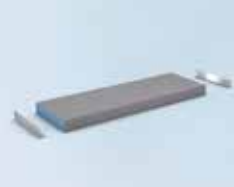
	Description	Length × Height × Depth	Unit	Item #
	wedi Sanoasa bench 4, straight	1200 × 380 × 80 mm	1 pc	US3000000



## wedi Joint Sealant | MS Polymer Sealant and Adhesive



Description	Contents	Unit	Item #
wedi Joint Sealant, MS polymer sealant	310 ml	1 Cartridge	US5000013
wedi Joint Sealant, MS polymer sealant	519.5 ml	1 Sausage	US5000010

**i** Permanently flexible, waterproof sealant and adhesive for joint treatment.

## wedi Sausage Gun | Gun for MS Polymer Sealant Sausages and Replacement Tips

Description	Unit	Item #
wedi Sausage Gun, gun for wedi joint MS polymer sealant sausages	1 piece	US5000019
wedi Sausage Gun Replacement Tip	per piece	US5000020

## wedi Accessories | Coarse Thread Screws, Ceramic Coating



Description	Length	Unit/Box	Item #
Coarse thread screws, ceramic coating	41.5 mm	100 pcs	US5000016
Coarse thread screws, ceramic coating	41.5 mm	1000 pcs	US5000012
89 mm Grip-Deck ci dacro galvanised coated coarse thread screws	89 mm	100 pcs	US5000050

**i** Phillips head for wood studs, premium ceramic coating (ACQ Compliant)

## wedi Accessories | Tab Steel Washers, galvanised



Description	Diameter	Unit/Box	Item #
Tab Steel Washers, galvanised	31.75 mm	100 pcs	US5000014
Tab Steel Washers, galvanised	31.75 mm	1000 pcs	US5000009
Washer, without tabs for flooring	31.75 mm	100 pcs	US5000015

**i** Tabbed washers provide four tabs for fast and secure placement. wedi Washers provide a solid gauge according to ISO standards and less potential for deformation. Load capabilities are independently tested.

## wedi Subliner Dry | Waterproofing and Crack-bridging Sheet Membrane



Description	Width × Roll Length	Unit	Item #
wedi Subliner Dry, waterproofing sheet membrane	5 × 1 m	1 roll	US5000001
wedi Subliner Dry, waterproofing sheet membrane	30 × 1 m	1 roll	US5000005

**!** Flexible waterproofing membrane for medium and high exposure wet areas – for interior walls/showers and steam showers.

## wedi Accessories | sealing tape, fleece laminated



Description	Roll Length × Width	Unit	Item #
wedi Accessories, sealing tape, fleece laminated	50 m × 100 mm	1 roll	09-51-00/352
wedi Accessories, sealing tape, fleece laminated	10 m × 120 mm	1 roll	09-51-10/311
wedi Accessories, sealing tape, fleece laminated	50 m × 120 mm	1 roll	09-51-10/352

## wedi Accessories | sealing gaiter

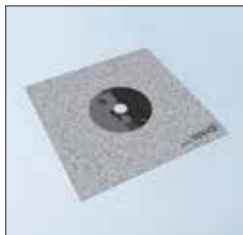

Description	Dimensions	Unit	Item #
wedi Accessories, sealing gaiter, fleece laminated, extendable	120 × 120 mm	1 pc	US5000033
Mixing Valve Flexi Collar	Diameter 127 mm	1 pc	US5000000

**i** Suitable for 12.7 mm to 19 mm feed-throughs.

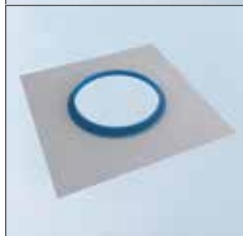

## Subliner Dry Accessories | Corner Sealing Tape, Fleece Laminated

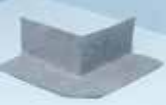
	Description	Dimensions	Unit	Item #
	Waterproof inside corner sealing tape, fleece laminated	120 × 120 × 57 mm	2 pcs	US5000007
	Waterproof outside corner sealing tape, fleece laminated	114 × 114 × 57 mm	2 pcs	US5000008

## wedi Tools | Corner Putty Knife

	Description	Unit/Bag	Item #
	wedi tools, corner putty knife for wedi shower system installations	1 pc	US5000044
<p><b>i</b> Use to smooth out wedi Joint Sealant applications.</p>			

# Riolito neo shower bases

## Off-center drain and linear drain

wedi's pre-sloped Fundo Primo offset base is the perfect fit for a tub replacement or any offset located drain in a shower. wedi's Fundo Riolito neo shower bases feature the ONLY fully sealed and factory integrated waterproof drain assembly. The level perimeter of these shower bases guarantees a perfect installation when recessing the base into a subfloor where a flush to the floor entry is required. The large, tileable and sloped areas around the drain make the tile installation clean and professional. These unique prefabricated and directly tileable units allow water to drain away through a narrow gap between the cover plate and adjacent tiling.

- Flexible drain location for maximum shower floor versatile
- Replaces the need for conventional bonding flange drain
- Fundo Riolito neo Modular can be used with dry pack or wedi sloped extension

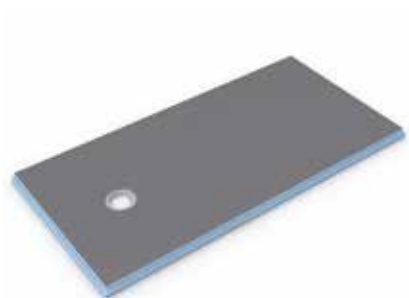

wedi Fundo Primo  
Dimensions: 914 × 1830 mm  
Art.: 07-37-35/521



wedi Fundo Riolito neo  
Dimensions: 813 × 1830 × 63 mm  
Art.: 07-51-00/035



wedi Fundo Riolito neo  
Dimensions: 813 × 1830 × 63 – 34 mm  
Art.: 07-51-00/015



wedi Fundo Riolito neo  
Dimensions: 1220 × 1830 × 51 mm  
Art: 07-51-00/014



wedi Fundo Riolito neo  
Dimensions: 1220 × 1524 × 63 mm  
Art: 07-51-00/012



wedi Fundo Riolito neo  
Dimensions: 914 × 1524 × 51 mm  
Art.-Nr.: 07-51-00/016

wedi Fundo Primo, Dimensions: 914 × 1830 mm

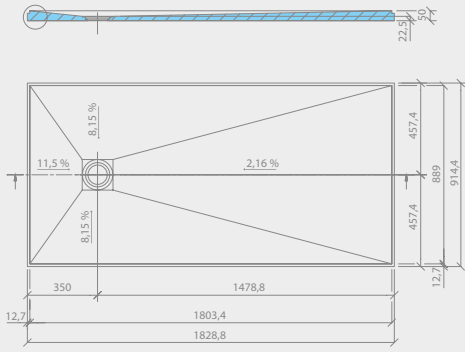

wedi Fundo Riolito neo, Dimensions: 914 × 1524 × 51 mm

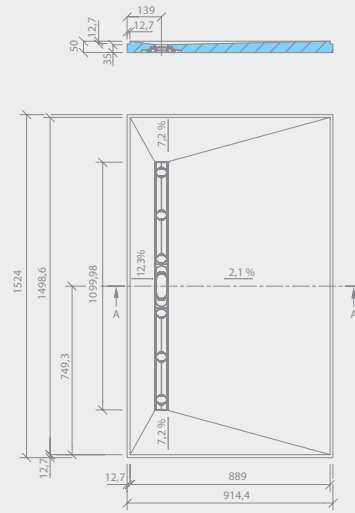

wedi Fundo Riolito neo, Dimensions: 1220 × 1830 × 51 mm

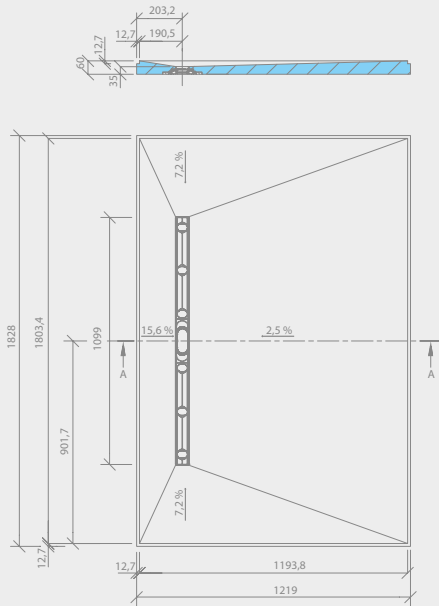

wedi Fundo Riolito neo, Dimensions: 1220 × 1524 × 63 mm

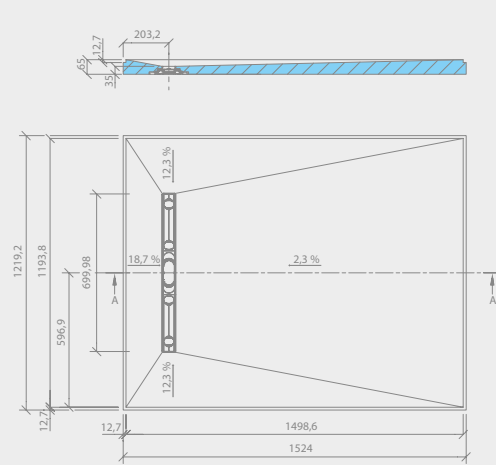

wedi Fundo Riolito neo, Dimensions: 813 × 1830 × 63 mm

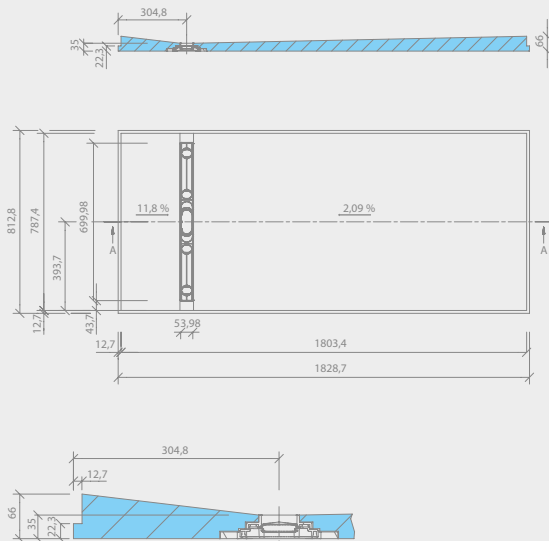

wedi Fundo Riolito neo, Dimensions: 813 × 1830 × 63 – 34 mm

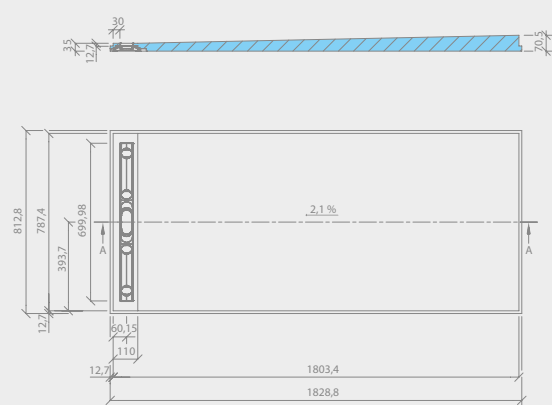

# wedi Fundo design showers

The inspiration to let your creative ideas take shape

Today, floor-level showers are practically a must-have in all public wellness facilities as they combine aesthetic requirements with a high level of functionality. The Fundo design concept unites creative lines with natural shapes and offers wall and floor elements to match the design series Trollo and Nautilo – either with or without supply channels.



wedi Fundo Trollo libero

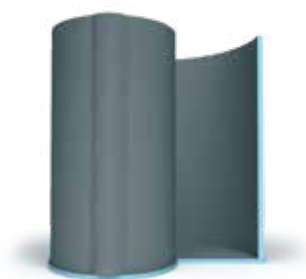

wedi Fundo Nautilo libero | Right hand entry

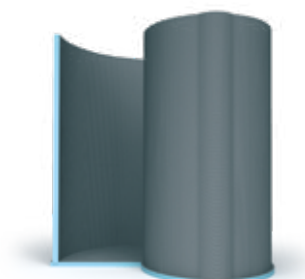

wedi Fundo Nautilo libero | Left hand entry



wedi Fundo Trollo

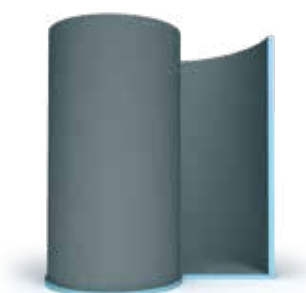

wedi Fundo Nautilo | Right hand entry

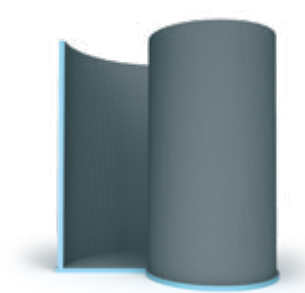

wedi Fundo Nautilo | Left hand entry





# wedi Sanoasa

## The simplicity of creating wellness areas with a modular system

Sanoasa benches are available in so many different designs, meaning that they can be built into almost any seating combination. Whether we are talking about benches, corner constructions or clean end solutions, once individually tiled, they set the scene in all bathrooms and wellness areas.



wedi Sanoasa Comoda



wedi Sanoasa Bellina

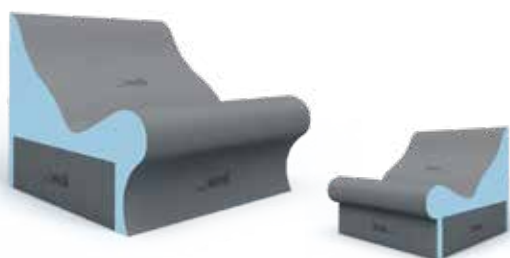

wedi Sanoasa Forma ▲  
wedi Sanoasa Forma Linea ►



wedi Sanoasa Collina ▲  
wedi Sanoasa Collina Linea ►

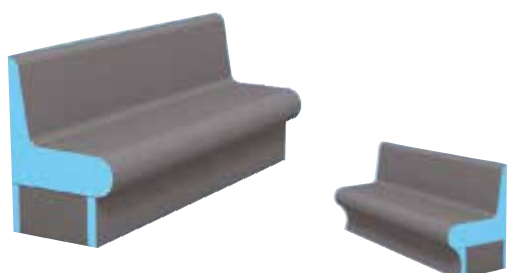

wedi Sanoasa Comoda ▲  
wedi Sanoasa Comoda linea ►

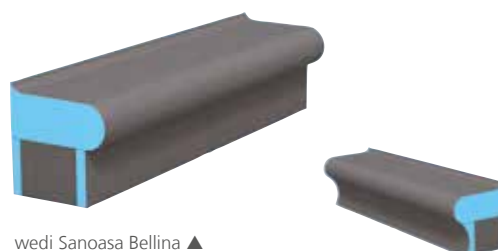

wedi Sanoasa Bellina ▲  
wedi Sanoasa Bellina linea ►

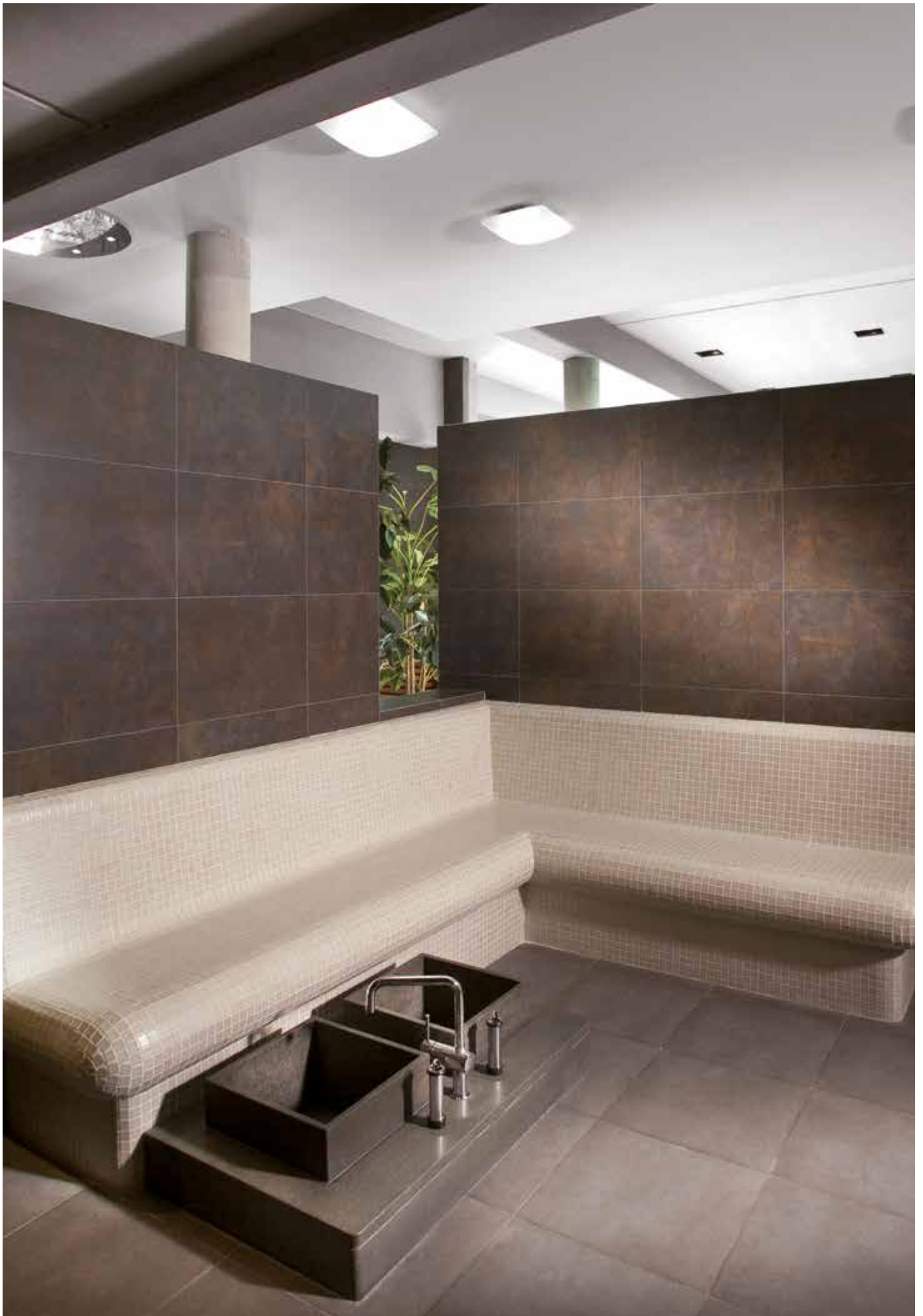

# wedi Sanoasa

## Installation Instructions

wedi Sanoasa bathroom and wellness objects are absolute highlights in both private and commercial applications. The designs stand out thanks to their unique forms and high levels of functionality. wedi wellness objects are the perfect solution wherever the focus is on relaxation in high quality wellness areas – and they can be refined at any time according to individual customer requirements.

### Sanoasa benches

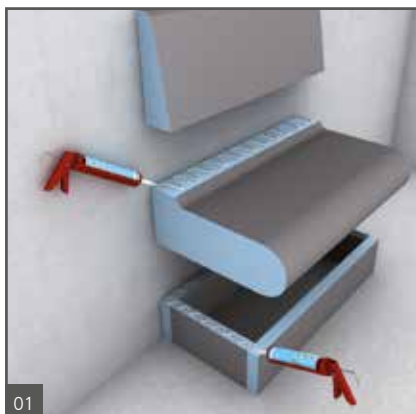

Connect seat and backrest ...

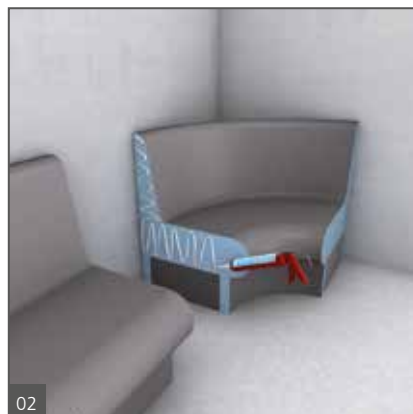

... arrange as desired ...

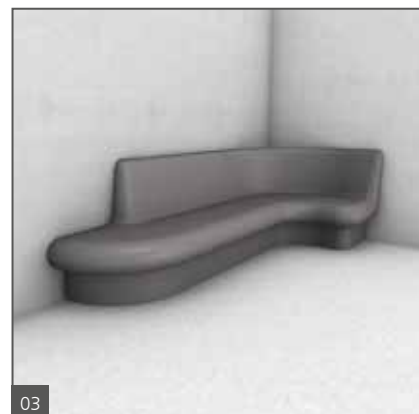

... finished, ready for tiling!

### Sanoasa Loungers



Position ...

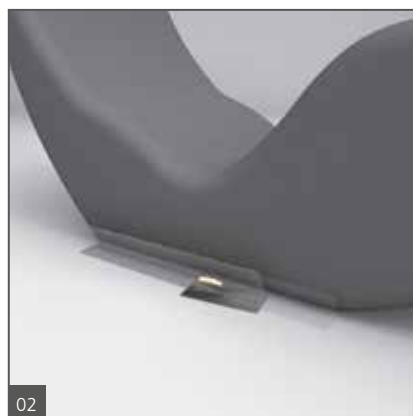

... set up ...



... finished, ready for tiling!



# wedi Custom Wellness & Spa Design Solution

Endless Possibilities for Residential and Commercial Spa's



- Hospitality
- Fitness Centers
- Universities
- Dormitories



## We are here to help you from the beginning to finish

Starting an new custom project, residential or commercial steam room? Do you need custom loungers? From idea to installation, you have our promise wedi will support your right from the start. The moment you contact us, our team springs into action. We generate custom CAD drawings based upon your ideas and plans. We test all the assemblies to ensure everything works flawless before we supply you with all the components, ready to install. We understand products are just part of the project. That's why we create and work in tandem with your lighting concepts, heating systems and preferred shower technology.

### 1 Your idea

As you envision your wellness concept, contact wedi and we can help bring your idea to life.

### 2 We plan together

wedi provides integrated project planning to ensure all components, shower technologies, drains and supply pipes are incorporated into your vision and unified for proper performance.

### 3 Made-to-measure products

With your approval, we produce solutions that fit your specifications and requirements perfectly. Then we assure the system measures up in terms of performance through to trial assemblies at our factory all prior to shipping.

### 4 On time delivery

We deliver all prefabricated components on time and in their entirety, with complete step-by-step assembly instructions so you can take your idea and bring it to life!



wedi – Preferred Supplier for



**HILTON**  
WORLDWIDE



## Did you know?

Great Quality Installation results depend on not only having great products to use – the Know-How and Experience in how to use them is key too. wedi trained and certified all Baumler Quality Construction installers in my team and now they fully know and appreciate what they can achieve with wedi.

This educational service is offered to all professional contractors of all trades and wedi's local Technical Sales Support Managers come out on site and install with you when you do your first wedi shower installation. Your peace of mind – at no charge. Just a call away!



wedi Australia & New Zealand

Phone: 0437 678 459

info@wedi.com.au  
www.wedi.com.au



Be sure to ask for:  
Certified wedi Installer.

Your local wedi distributor:

